

YD201
FREQUENCY INVERTER

Yolico
MIYAKAWA GROUP



User Manual

Fan and Pump Application

Model : YD201-□□□□-□□

Power Range:

1-phase 220V series:0.4~2.2kW (0.5~3HP)
3-phase 220V series:2.2~3.7kW (3~5HP)
3-phase 380V series:0.75~710kW(1~946HP)

Yolico

MIYAKAWA GROUP



Yolico

WUXI YOLICO ELECTRIC CO., LTD.

Add: No.9 LianHe Road, HuDai Industrial Park, BinHu Borough, Wuxi, China.

Tel: +86-0510-85161131 Fax: +86-0510-85161139

[Http://www.yolico.com](http://www.yolico.com)



Service Hotline: 400 0510 133

2016. 08. V0. 1

Yolico can accept no responsibility for possible errors in these printed materials. Yolico retains the right to change specifications and illustrations in the text, without prior notification. The contents of this document may not be copied without the explicit permission of Yolico.

Content

Safety Instruction.....	I
1. Introduction.....	1-1
Overview.....	1-1
1.1 Nameplate Information.....	1-1
1.2 Model Code Configuration.....	1-1
1.3 General Technical Data.....	1-3
2. Surrounding and Installation.....	2-1
2.1 Surrounding.....	2-1
2.2 Mounting and Installation.....	2-1
2.3 Installing Position.....	2-2
2.4 Appearances and Mechanical Dimensions.....	2-3
2.5 Operator Mechanical Dimension.....	2-4
2.6 Operator Punch/ Drill Hole Dimension.....	2-4
2.7 Removing the Operator.....	2-5
3. Wiring & Terminals.....	3-1
3.1 All Electrical Wiring Terminals Diagram.....	3-1
3.2 Mains Circuit Terminals Description.....	3-2
3.3 Mains Terminals Configuration.....	3-2
3.4 Control Terminals Description.....	3-3
3.5 Control Terminals Configuration.....	3-3
3.6 Terminal Tightening Torque and Cable Size in Installation.....	3-4
3.7 Wiring Regulation.....	3-4
4. LCP Introduction.....	4-1
4.1 Brief Functions of LCP.....	4-1
4.2 Monitor Display (Ux-XX).....	4-2
4.3 Operation via the LCP.....	4-3
4.3.1 The Display.....	4-3
4.3.2 Functions of LED Display.....	4-3
4.3.3 ↑ Increment/ ↓ Decrement Functions Structure.....	4-4
4.3.4 LCP Operating Example.....	4-4
4.3.5 Command and Reference Relation.....	4-6
5. Parameter Introduction.....	5-1
5.1 Parameters Reading.....	5-1
5.1.1 Parameters List.....	5-2
5.2 Initialization, Group (A).....	5-3
5.2.1 Initialization Set-up: A1.....	5-3
5.3 Application, Group (B).....	5-4
5.3.1 Sequence: B1.....	5-4
5.3.2 DC Brake: B2.....	5-6
5.3.3 Speed Search: B3.....	5-6
5.3.4 PID Control: B5.....	5-7
5.4 Tuning, Group (C).....	5-11
5.4.1 Acceleration/ Deceleration Time: C1.....	5-11
5.4.2 S Curve Accel/ Decel: C2.....	5-11
5.4.3 Motor Slip Compensation at V/F Control: C3.....	5-12
5.4.4 Torque Compensation: C4.....	5-12
5.4.5 Carrier Frequency: C6.....	5-12

5.5 Reference, Group (D).....	5-13
5.5.1 Preset References: D1.....	5-13
5.5.2 References Limits: D2.....	5-16
5.5.3 Jump Frequencies: D3.....	5-17
5.6 Motor, Group (E).....	5-18
5.6.1 V/F Pattern: E1.....	5-18
5.6.2 Motor Set-up: E2.....	5-22
5.6.3 Operating Direction Definition: E6.....	5-22
5.7 Terminal, Group (H).....	5-23
5.7.1 Digital Inputs: H1.....	5-23
5.7.2 Digital Outputs: H2.....	5-29
5.7.3 Analog Inputs: H3.....	5-32
5.7.4 Analog Outputs: H4.....	5-35
5.7.5 Serial Communication (Modbus) Set-up: H5.....	5-36
5.8 Protection, Group (L).....	5-38
5.8.1 Motor Overload: L1.....	5-38
5.8.2 Power Loss Ridethrough: L2.....	5-39
5.8.3 Stall Prevention: L3.....	5-40
5.8.4 Reference Detection: L4.....	5-42
5.8.5 Automatic Restart: L5.....	5-42
5.8.6 Over Current Detection L6.....	5-44
5.8.7 Hardware Protection: L8.....	5-44
5.9 Operator, Group (O).....	5-45
5.9.1 Monitor Selection: O1.....	5-45
5.9.2 Key Selection: O2.....	5-45
5.10 Process, Group (P).....	5-47
5.10.1 Auto Process Operation: P1.....	5-47
5.11 VVT Adjusting, Group (T).....	5-51
5.11.1 Motor Nameplate Data: T1.....	5-51
5.11.2 Motor Adjusting Constants: T2.....	5-51
6. Fault Code and Troubleshooting.....	6-1
6.1 Warning/ Fault Condition, the Possible Causes of Problem.....	6-1
6.1.1 VFD Faults & Remedy.....	6-1
6.1.2 VFD Warnings & Remedy.....	6-3
6.1.3 VFD Special Conditions & Remedy.....	6-4
6.1.4 VFD Operation Error & Remedy.....	6-5
7. Maintenance and Inspection.....	7-1
7.1 Maintenance and Inspection.....	7-1
A. Appendix.....	A-1
A.1 Dynamic Braking Configuration.....	A-1
A.2 Parameter List Table.....	A-2
A.3 Abbreviation Index.....	A-9

Safety Instruction

Instruction Manual

Read this instruction manual first before using the Frequency Converter (AC Drive, VFD, Inverter, Frequency Inverter).

The following symbols may appear in this manual, always read these before continuing.



WARNING

FAILURE TO FOLLOW THESE INSTRUCTIONS MAY RESULT IN SERIOUS INJURY OR DEATH TO THE USER, PROPERTY DAMAGE, OR ECONOMIC LOSS.



CAUTION

FAILURE TO FOLLOW THESE INSTRUCTIONS MAY RESULT IN MALFUNCTION OR VFD DAMAGE.



Heat Warning

BE AWARE OF SPECIFIC PARTS ON THE VFD HAVING HIGH TEMPERATURE MAY RESULT IN INJURY.

Handling the VFD



WARNING

- INSTALLATION, COMMISSIONING, DEMOUNTING, TAKING MEASUREMENTS, ETC, OF OR ON THE VFD MAY ONLY BE CARRIED OUT BY PERSONNEL TECHNICALLY QUALIFIED FOR THE TASK.
- THE INSTALLATION MUST BE CARRIED OUT IN ACCORDANCE WITH LOCAL STANDARDS.

ESD Protection



CAUTION

PCB BOARDS IN VFD WITH CMOS COMPONENTS, OBSERVE PRECAUTION FOR HANDLING ELECTROSTATIC SENSITIVE DEVICES.

Opening the VFD



WARNING

- ALWAYS SWITCH OFF THE MAIN POWER BEFORE OPENING THE VFD AND WAIT AT LEAST 10 MINUTES TO ALLOW THE BUFFER CAPACITOR TO DISCHARGE.
- ALWAYS TAKE ADEQUATE PRECAUTIONS BEFORE OPENING THE VFD. ALTHOUGH THE CONNECTIONS FOR THE CONTROL SIGNALS AND THE SWITCHES ARE ISOLATED FROM THE MAIN VOLTAGE, DO NOT TOUCH THE CONTROL BOARD OR MAKE A WIRING WHEN THE VFD IS SWITCHED ON.

Precautions to be taken with a connected Motor



WARNING

If work must be carried out on a connected Motor or on the Driven Machine, some Actions must be taken below:

- THE MAINS VOLTAGE MUST ALWAYS BE DISCONNECTED FROM THE VFD FIRST. WAIT AT LEAST 10 MINUTES BEFORE STARTING WORK.
- A SEPARATE EMERGENCY STOP SWITCH IS REQUIRED, THE STOP KEY ON DIGITAL OPERATOR IS VALID ONLY WHEN ITS FUNCTION IS SET TO ENABLE.

Earth and Grounding



WARNING

THE VFD MUST ALWAYS BE EARTHED VIA THE MAINS SAFETY EARTH/ GROUND CONNECTION. THE GROUNDING RESISTANCE MUST BE 10Ω OR LESS OR COMPLY WITH NATIONAL/ LOCAL SAFETY REGULATION.

Earth Leakage Current



WARNING

This Earth Leakage Current of VFD does exceed 3.5 mAAC. Therefore the minimum size of the protective Earth Conductor must comply with the Local Safety Regulations for High Leakage Current equipment which means that according the Standard IEC61800-5-1 the protective earth connection must be assured by one of following conditions:

- USE A PROTECTIVE CONDUCTOR WITH A CABLE CROSS-SECTION OF AT LEAST 10 MM² FOR COPPER (CU) OR 16 MM² FOR ALUMINUM (AL).
- USE AN ADDITIONAL PE WIRE, WITH THE SAME CABLE CROSS-SECTION AS THE USED ORIGINAL PE AND MAINS.

Mains Voltage Selection



CAUTION

The VFD may be ordered for use with the Mains Supply Voltage range listed below.

YD201-T2S: AC 1Ø 200- 240V, +10%, -10%

YD201-T2: AC 1/ 3Ø 200- 240V, +10%, -10%

YD201-T4: AC 3Ø 380- 480V, +10%, -10%

- VFD MAY DAMAGE BY INCORRECT MAINS VOLTAGE SUPPLIED.

Voltage Test (Megger)



CAUTION

DO NOT CARRY OUT VOLTAGE TESTS (MEGGER) ON THE MOTOR, BEFORE ALL THE MOTOR CABLES HAVE BEEN DISCONNECTED FROM THE VFD

Condensation

CAUTION

IF THE VFD IS MOVED FROM A COLD (STORAGE) ROOM TO A ROOM WHERE IT WILL BE INSTALLED, CONDENSATION CAN OCCUR. THIS CAN RESULT IN SENSITIVE COMPONENTS BECOMING DAMP. DO NOT CONNECT THE MAINS VOLTAGE UNTIL ALL VISIBLE DAMPNES HAS EVAPORATED

Incorrect Connection

CAUTION

THE VFD IS NOT PROTECTED AGAINST INCORRECT CONECTION OF THE MAINS VOLTAGE, AND IN PARTICULAR AGAINST CONNECTION OF THE MAINS VOLTAGE TO THE MOTOR LEADS U, V AND W. THE VFD CAN BE DAMAGED IN THIS WAY.

Power Factor Capacitors for improve COSØ

CAUTION

REMOVE ANY POWER FACTOR IMPROVING CAPACITORS FROM THE VFD OUTPUT SIDE, MOTOR AND THE MOTOR LEADS.

Precautions during Autoreset and Autorestart

WARNING

WHEN THE AUTOMATIC RESET IS ACTIVE, THE MOTOR WILL RESTART AUTOMATICALLY PROVIDED THAT THE CAUSE OF THE TRIP HAS BEEN REMOVED. IF NECESSARY TAKE THE APPROPRIATE PRECAUTIONS.

Electromagnetic Contactor



CAUTION

REMOVE ANY ELECTROMAGNETIC CONTACTOR BETWEEN THE VFD OUTPUT SIDE AND MOTOR.

DC-Link Residual Voltage



WARNING

AFTER SWITCH OFF THE MAINS SUPPLY, DANGEROUS VOLTAGE CAN STILL BE PRESENT IN THE VFD. WHEN OPENING THE VFD FOR INSTALLING AND/OR COMMISSIONING ACTIVITIES WAIT AT LEAST 10 MINUTES. IN CASE OF MALFUNCTION A QUALIFIED TECHNICIAN SHOULD CHECK THE DC-LINK OR WAIT FOR HALF HOUR BEFORE DISMANTLING THE VFD FOR REPAIR.

Motor Overload Protection



CAUTION

TO PROTECT MOTOR IN OVERLOAD SITUATION, SET THE MOTOR OL PROTECTION FUNCTION OF VFD TO ENABLE.

Transport



CAUTION

TO AVOID DAMAGE, KEEP THE VFD IN ITS ORIGINAL PACKAGING DURING TRANSPORT. THIS PACKAGING IS SPECIALLY DESIGNED TO ABSORB SHOCKS DURING TRANSPORT.

Hot Surface



Heat Warning



BE AWARE OF HEAT FINS OR SOME SPECIFIC PARTS ON THE VFD HAVING HIGH TEMPERATURE MAY RESULT IN INJURY.

1. Introduction

Overview

The Purpose of this Manual is to provide you with the Basic Information Needed to Installation, Start-up, Program and Troubleshoot the YD201 Frequency Converter. In the Course of using, in case of Any Problems not covered by this Manual, please contact Local Yolico Representatives or Engineering Technical Personnel from our Company. Our Professional Staff is glad to Serve you. Please continue to use this Product.

1.1 Nameplate Information

	INVERTER	YOLICO ELECTRIC CO.,LTD.
Model Code and applicable Motor Rating	MODEL : YD201-00P7-T4	
	MOTOR RATING : 1.0HP/0.75kW	
Power Supply Rating	INPUT VOLTAGE : AC 3 phases 50/60Hz	
	VOLTAGE : 380-480V (±10%,)	
Output Rating	OUTPUT VOLTAGE : AC 3 phases 0-650Hz	
	VOLTAGE : 0-480V	
	CURRENT : 2.3A	
LOT and Serial Number	LOT. NO. : 69D06008	
	SER. NO. : 	
	Yolico	No.9,LianHe Road,HuDai Industrial Park,BinHu Borough,Wuxi,China

1.2 Model Code Configuration

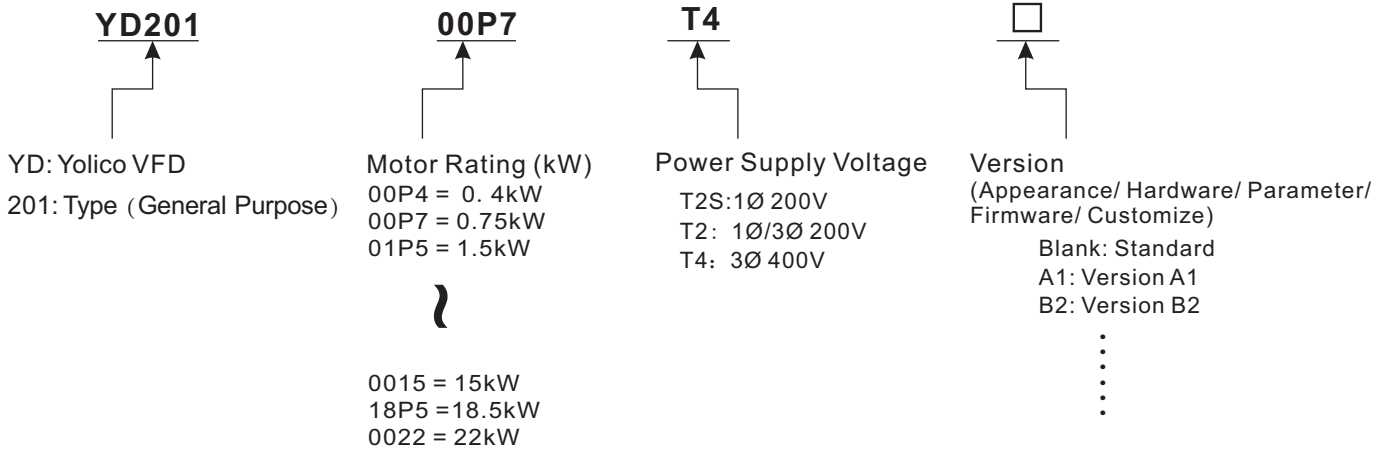

Model List (200V)

Model Code	Output Rating			Dimension (mm) H × W × D	Frame Size
	Motor (kW)	VA (kVA)	Current (A)		
YD201-00P4-T2S	0.4	1.2	3.1	160×79×126	A
YD201-00P7-T2S	0.75	1.7	4.5		
YD201-01P5-T2S	1.5	2.9	7.5	160×93×126	A1
YD201-02P2-T2S	2.2	4.0	10.5	160×100×126	A2
YD201-03P7-T2	3.7	6.7	17.5	210×100×160	B

Model List (400V)

Model Code	Output Rating			Dimension (mm) H × W × D	Frame Size
	Motor (kW)	VA (kVA)	Current (A)		
YD201-00P4-T4	0.4	1.2	1.2	160×79×126	A
YD201-00P7-T4	0.75	1.7	2.3		
YD201-01P5-T4	1.5	2.9	4.0	160×93×126	A1
YD201-02P2-T4	2.2	4.0	5.2	160×100×126	A2
YD201-0003-T4	3.0	5.5	7.2		
YD201-0004-T4	4.0	7.3	10.5	210×100×160	B
YD201-05P5-T4	5.5	9.9	13.0		
YD201-07P5-T4	7.5	13.3	17.5		
YD201-0011-T4	11.0	19.1	25.0	270×135×200	C
YD201-0015-T4	15.0	27.4	32.0		
YD201-18P5-T4	18.5	41.0	40.0	300×155×220	D
YD201-0022-T4	22.0	50.0	45.0		
YD201-0030-T4	30.0	54.0	65.0	400×250×230	E

Note: YD201-00P4-T4 by Requested with MOQ.

Model List (400V)

Model Code	Output Rating			Dimension (mm) H × W × D	Frame Size
	Motor (kW)	VA (kVA)	Current (A)		
YD201-0037-T4	37	61	80	520 × 321 × 270	F
YD201-0045-T4	45	73	96		
YD201-0055-T4	55	98	128		
YD201-0075-T4	75	130	145		
YD201-0093-T4	93	140	180	620 × 400 × 300	G
YD201-0110-T4	110	170	224		
YD201-0132-T4	132	200	260		
YD201-0160-T4	160	230	302	720 × 495 × 330	H
YD201-0185-T4	185	260	340	300 × 155 × 220	I
YD201-0200-T4	200	300	380		
YD201-0220-T4	220	340	455		
YD201-0250-T4	250	380	470		
YD201-0280-T4	280	460	530	960 × 670 × 370	J
YD201-0315-T4	315	460	605		
YD201-0355-T4	355	490	670		
YD201-0400-T4	400	519	738	1800 × 1000 × 600	K
YD201-0450-T4	450	585	864		
YD201-0500-T4	500	650	984		
YD201-0550-T4	550	722	1000	1800 × 1200 × 600	L
YD201-0630-T4	630	780	1185		
YD201-0710-T4	710	890	1234		

1.3 General Technical Data

Mains Supply(L1,L2,L3)/(L1,L2)/(R,S,T)	
Mains Voltage	1x200- 240V ± 10%
	3x200- 240V ± 10%
	3x380- 480V ± 10%
Mains Frequency	50/ 60Hz ± 5%
Mains Protection	Surge Absorber

Output (U,V,W)	
Control Method	V/F or VVT
Output Frequency	0- 650Hz (V/F CTL)
	0- 200Hz (VVT CTL)
Torque at Starting	120%/ 3Hz (V/F CTL)
	150%/ 1Hz (VVT CTL)
Output Voltage	0-100% Mains Voltage
Carrier Frequency	1- 10K Hz, Programable
ACC./ DEC Time	0.1- 3600 Sec.
Load Duty	120%/ 60 Sec., 180%/ 3 Sec.

PHC Output (DO,DOG) For 400V, 7.5-22 kW	
Number of Output	1(11kW-22kW/380V)
	2(30kW-710kW/380V)
Specification	DC48V/ 50mA (Open-Collector)

Serial Communication (A, B, SG)	
Number of Serial Port	1
Station QTY	1- 32 Stations (120Ω)
Protocol	Modbus RTU/ ASCII
Baud Rate	1200-19200 BPS

Surrounding	
Enclosure	0.4-22kW IP20
	30-355kW IP00
	400-715kW IP20
Operating Temperature	-10° C~ +40° C (Ambient)

Local Control Panel (LCP, Keypad, Operator)	
Display	5×8 Segment Display+ 4×LEDs
Number of Key	6Keys (RUN/STOP/UP/DOWN/MODE/ENT←)
POT	Dust, Oil Preserving Cover Design
Remote Operator	Standard CAT5 Cable, Applicable 1-3M

Analog Output (AO)	
Number of Output	1(0.4-22kW)
	2(30-710kW)
Signal Type	Voltage
Signal Level	0- 10V
Maximum Current	2mA
Inaccuracy	1% of Full Scale

RelayOutput(RA-RC/R1A-R1C&R2C-R2A/R2B)	
Number of Relay	1: RA-RC, Frame Size A and A1
	2: R1A-R1C and R2A,R2B-R2C, Frame B to L
Relay Type	RA-RC/ R1A-R1C/ R2A-R2C: Make (N.O.) R2B-R2C: Break (N.C.)
Specification	250VAC/5A, 30VDC/2A Max.
Activating Response Time	10ms/ per time

Digital Inputs (D1- D6)	
Number of Inputs	6
Logic	NPN
Number of Common	2 off COM
Voltage Level	0-24V, >12V ON
Max. Voltage	28V
Input Resistance (Ri)	4kΩ

PWM/ Pulse Train Input (D6)	
Number of Input	1
Voltage Level	0-24V, >12V ON
Frequency	10- 10k Hz (Pulse)/ 10- 1k Hz (PWM)
Inaccuracy	0.1% FSD

Analog Inputs (AVI, ACI)	
Number of Input	2:(0.4-22kW)
	3:(30-710kW)
Signal Type	AVI: Voltage type
	ACI:Current type
	AUX:Mixed type
Signal Level of AVI	10V/ 2- 10V (20kΩ)
Signal Level of ACI	0- 20/ 4- 20mA (250Ω)
Resolution	1:4096(12 Bit AD)

2. Surrounding and Installation

2.1 Surrounding

To Enhance the Operation Reliability and Life Time of VFD, the VFD should be installed in an Environment for Temperature Increase Free, the VFD installing Surrounding Meet the Following Conditions

PROTECTION	
Cabinet	IP20
SURROUNDING	
Ambient Temperature	-10~ +50°C
Storage Temperature	-20~ +60°C
Max. Humidity	95%RH Non Condensing Please note that no VFD Freeze (Follow IEC 60068 -2-78)
Vibration Test	20Hz below- 1G(9.8m/s ²) 20~ 50Hz- 0.6G(5.88m/s ²)(Follow IEC 60068 -2-6)

2.2 Mounting and Installation

The VFD must be installed in a Location Free for.

- Direct Sunlight.
- Rain/ Moisture or Wet Environment.
- Oil Spray, Splashes or Salty Spray.
- Corrosive Gases (e.g. Sulfurized Gas) or Liquid.
- Physical Shock, Vibration, Using a Vibration Damper if the Vibration can't be avoid in the Environment.
- Magnetic Noise (e.g. Welding Machines, Ppower Device, etc.)
- Radioactive Substances, Combustible (e.g. Thinner, Solvents)
- Floating Dust/ Cotton Dust Metal Power or any Material into VFD

Note:

- ◆ The VFD must be mounted in a Vertical Position against Flat Surface, and the Frontage of VFD should Face Obverse. VFD may Overheat if mounted in a Incorrect Position.
- ◆ A VFD or VFDs installed in a Enclosure, be sure the Free Space for Cooling Effect, Yolico recommended the Free Space around VFD is 100mm for H and 50mm for W. please see Fig. 2-1. Table 2-1 shows the Minimum Free Space required around the VFD to Guarantee Adequate Cooling for all Frame Size .

2.3 Installing Position

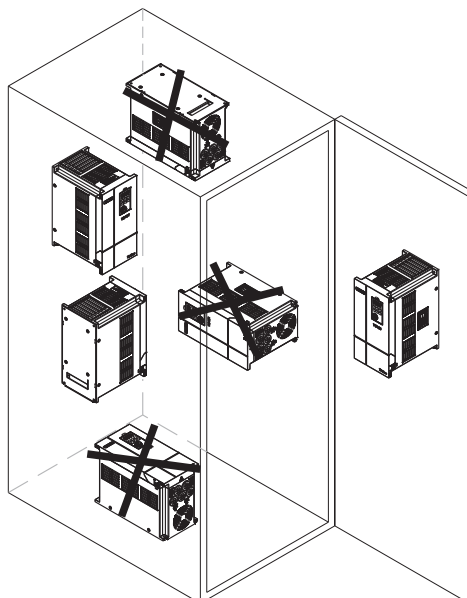

2.4 Appearances and Mechanical Dimensions

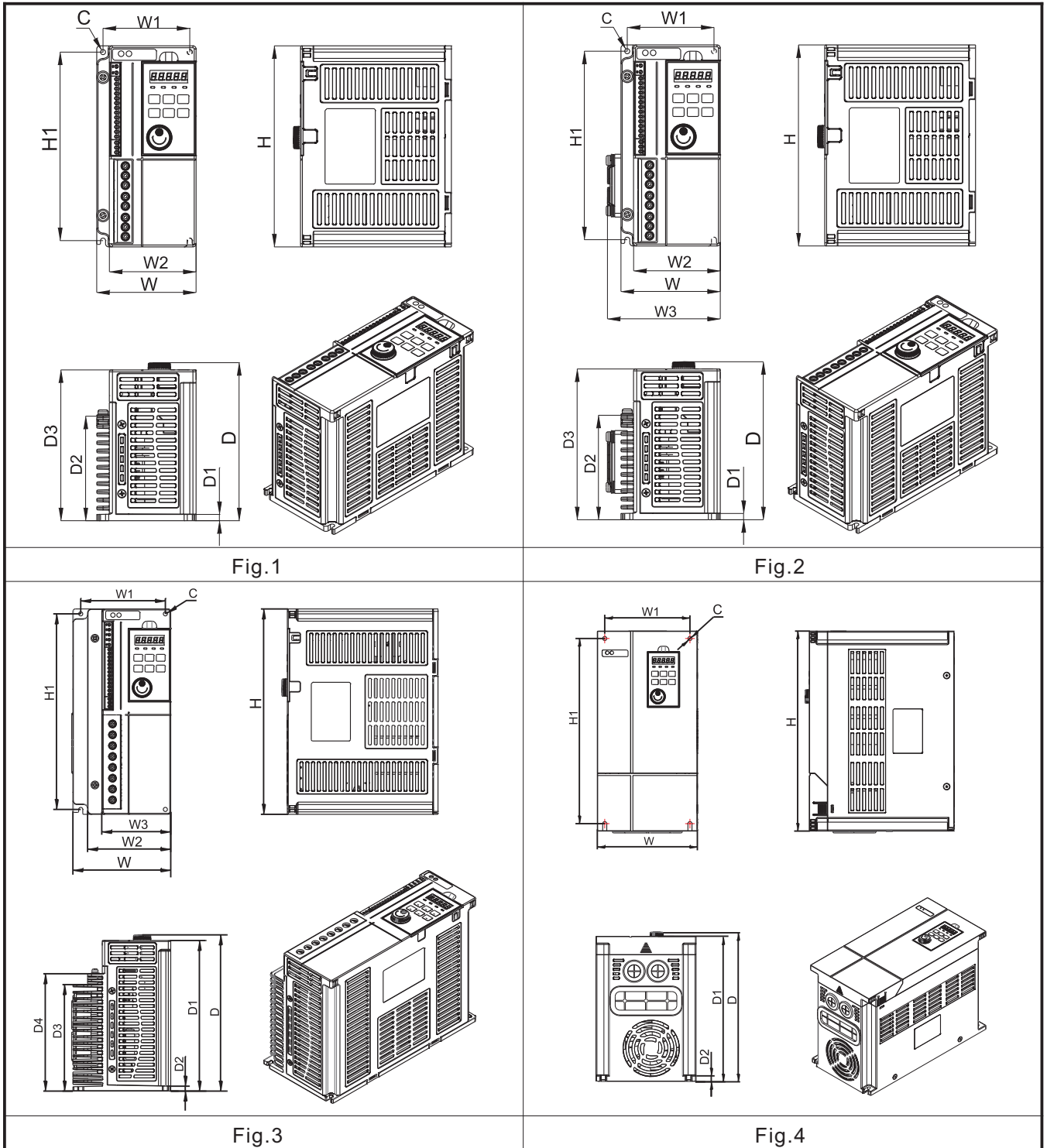

Tolerance +/- 0.5 mm

Frame Size	Dimension (mm)												Fig.
	H	H1	W	W1	W2	W3	D	D1	D2	D3	D4	C	
A	160	150	79	69	69	--	126	5	83	130	--	Ø4	Fig.1
A1/A2	160	150	79	69	69	93/100	126	5	83	120	--	Ø4	Fig.2
B	210	200	100	86.5	85	70.5	160	154	5	109	120	Ø5	Fig.3
C	270	250	135	115	--	--	200	195	8	--	--	Ø5	Fig.4
D	300	281	155	136	--	--	220	214.5	7	--	--	Ø6	

2.4 Appearances and Mechanical Dimensions

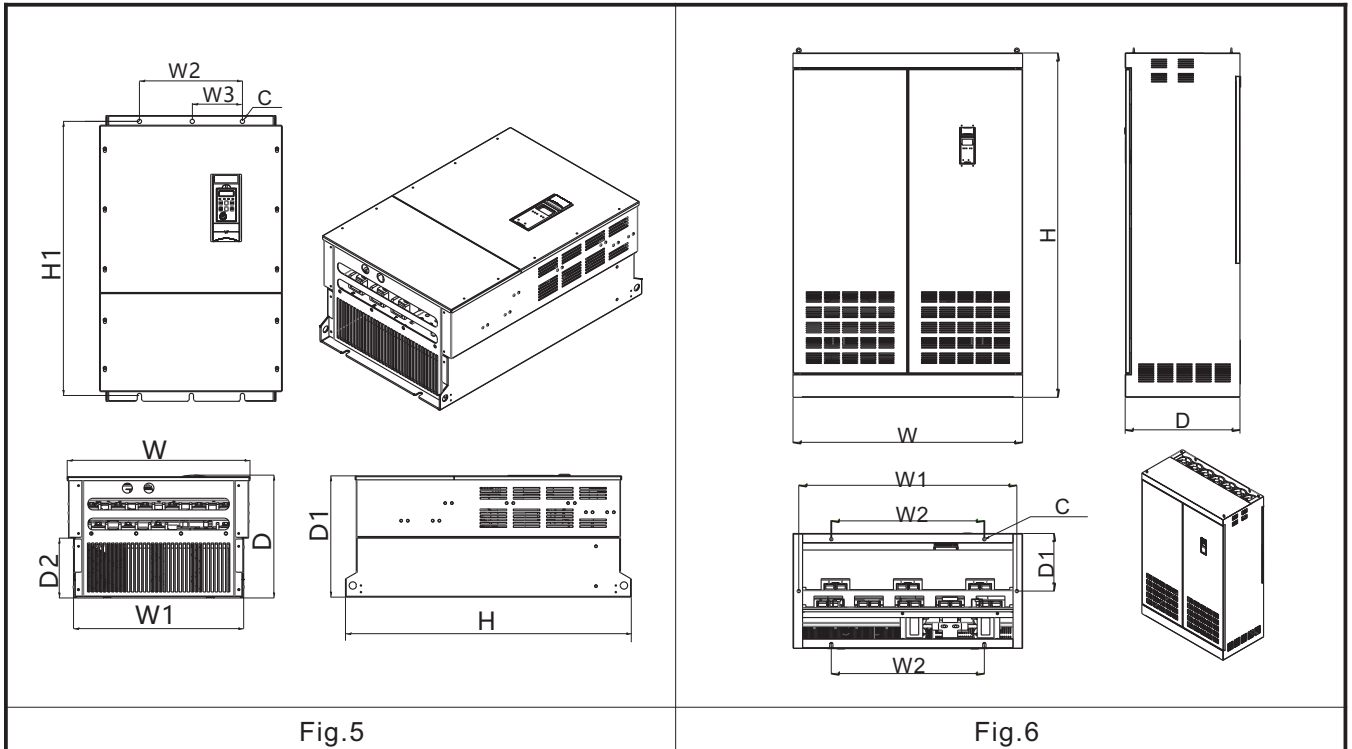

Tolerance +/- 0.5 mm

Frame Size	Dimension (mm)												Fig.
	H	H1	W	W1	W2	W3	D	D1	D2	D3	D4	C	
E	400	384	250	230	190	--	235	230	108	--	--	Ø6	Fig. 5
F	520	497	321	300	190	--	270	265	108	--	--	Ø10	
G	620	588	400	375	300	--	300	395	127	--	--	Ø10	
H	720	680	495	459	360	--	330	325	130	--	--	Ø12	
I	860	825	550	512	350	--	370	365	180	--	--	Ø13	
J	960	920	670	632	520	260	370	365	180	--	--	Ø13	Fig. 6
K	1800	--	1000	956	800	--	600	300	--	--	--	Ø15	
L	1800	--	1200	1140	800	--	600	300	--	--	--	Ø15	

2.5 Operator Mechanical Dimension

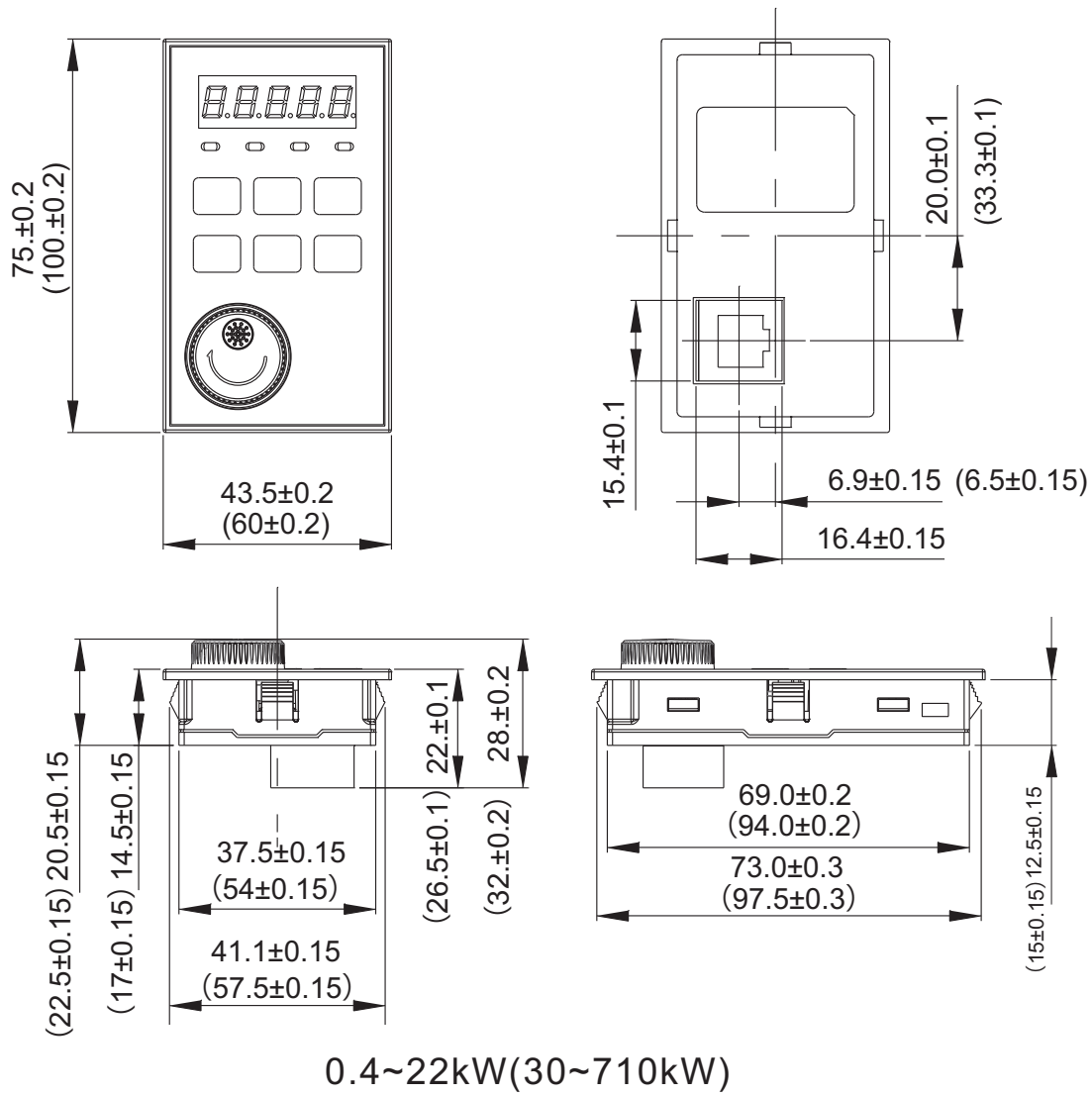

2.6 Operator Punch/ Drill Hole Dimension

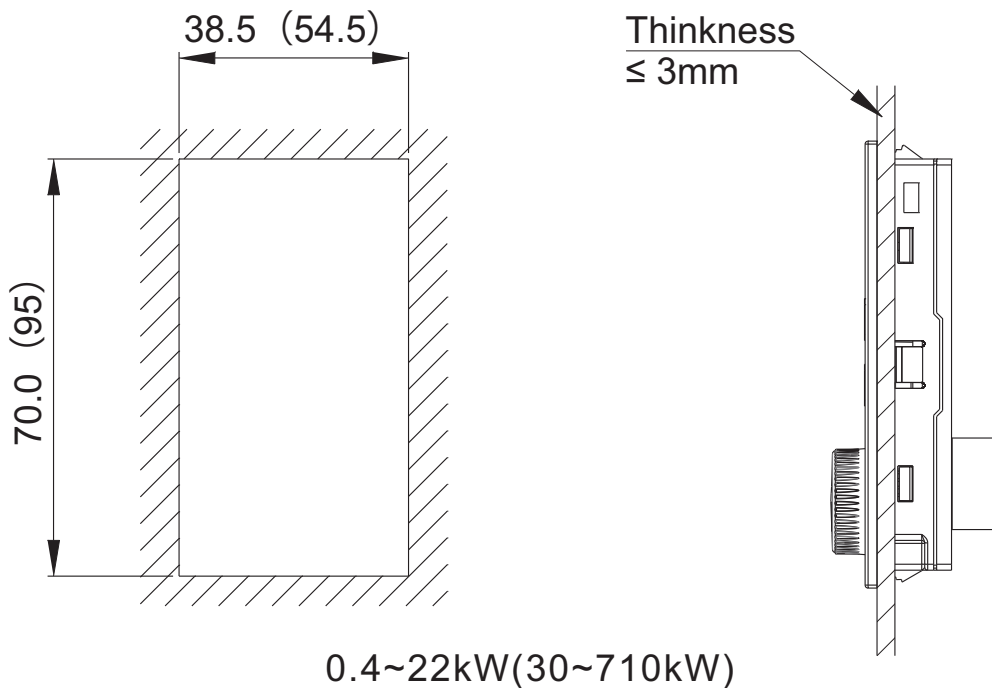

2.5 Operator Support Mechanical Dimension

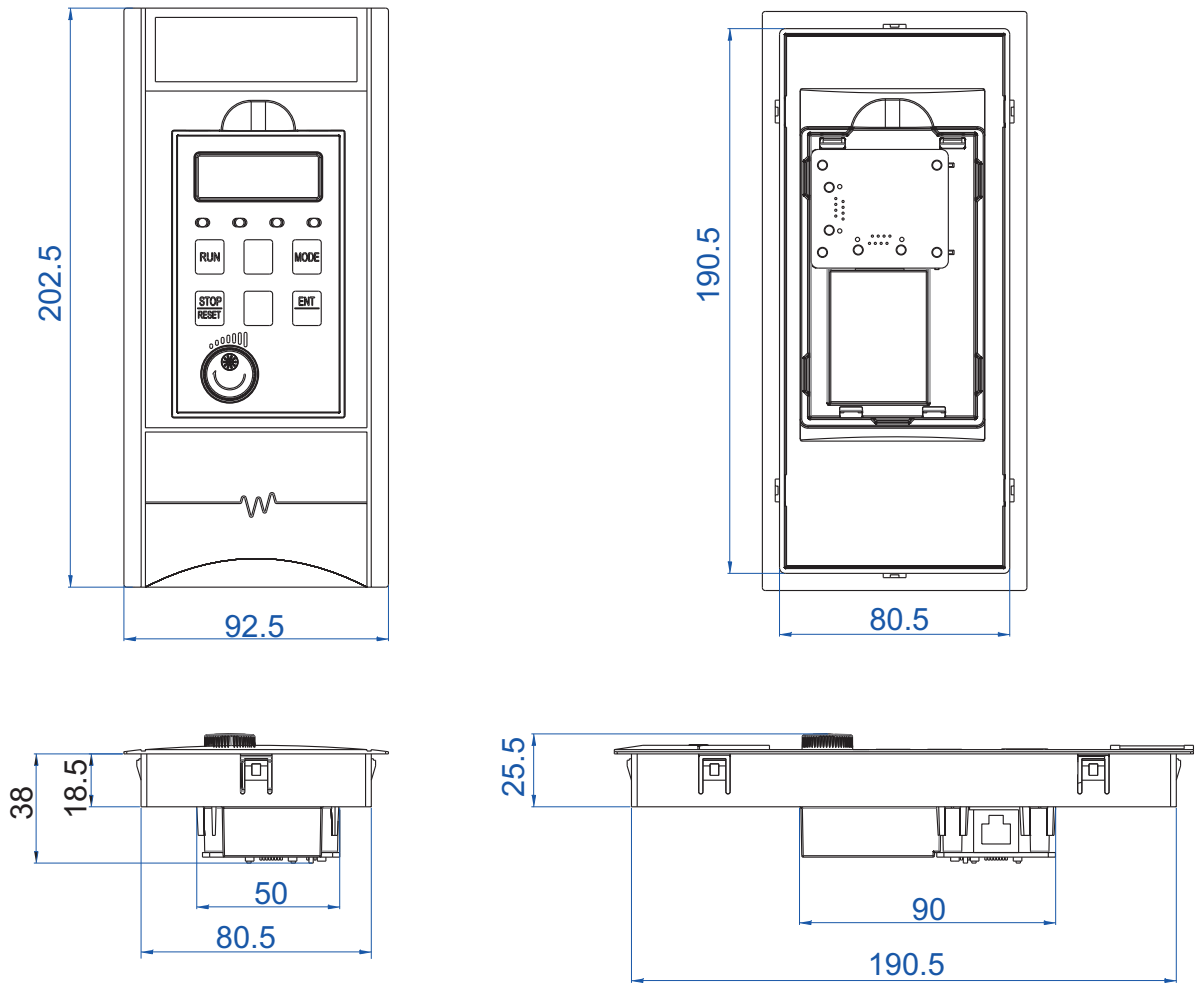

30~710kW

2.6 Operator Support Punch/ Drill Hole Dimension

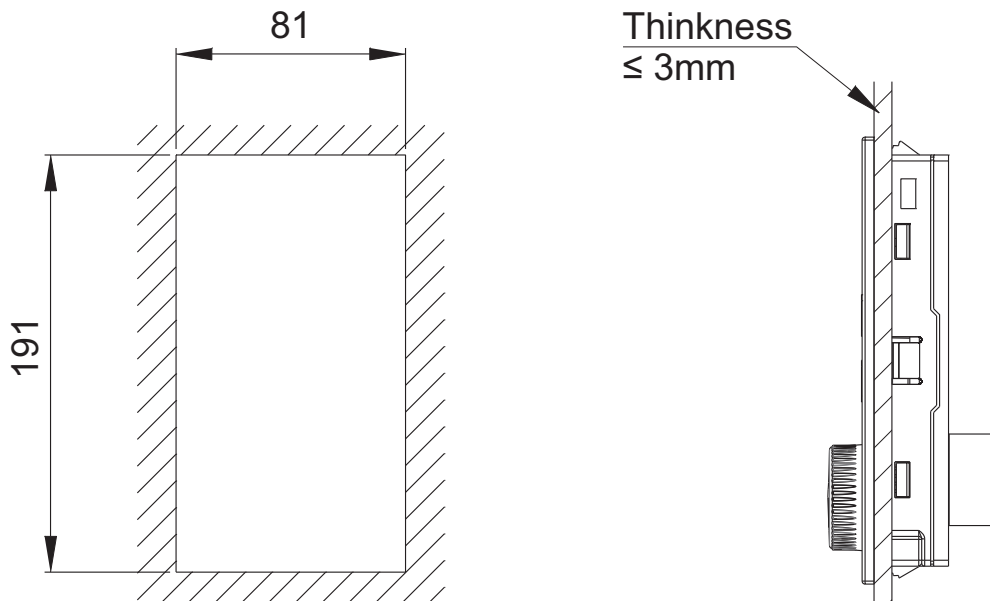

30~710kW

2.7 Removing the Operator

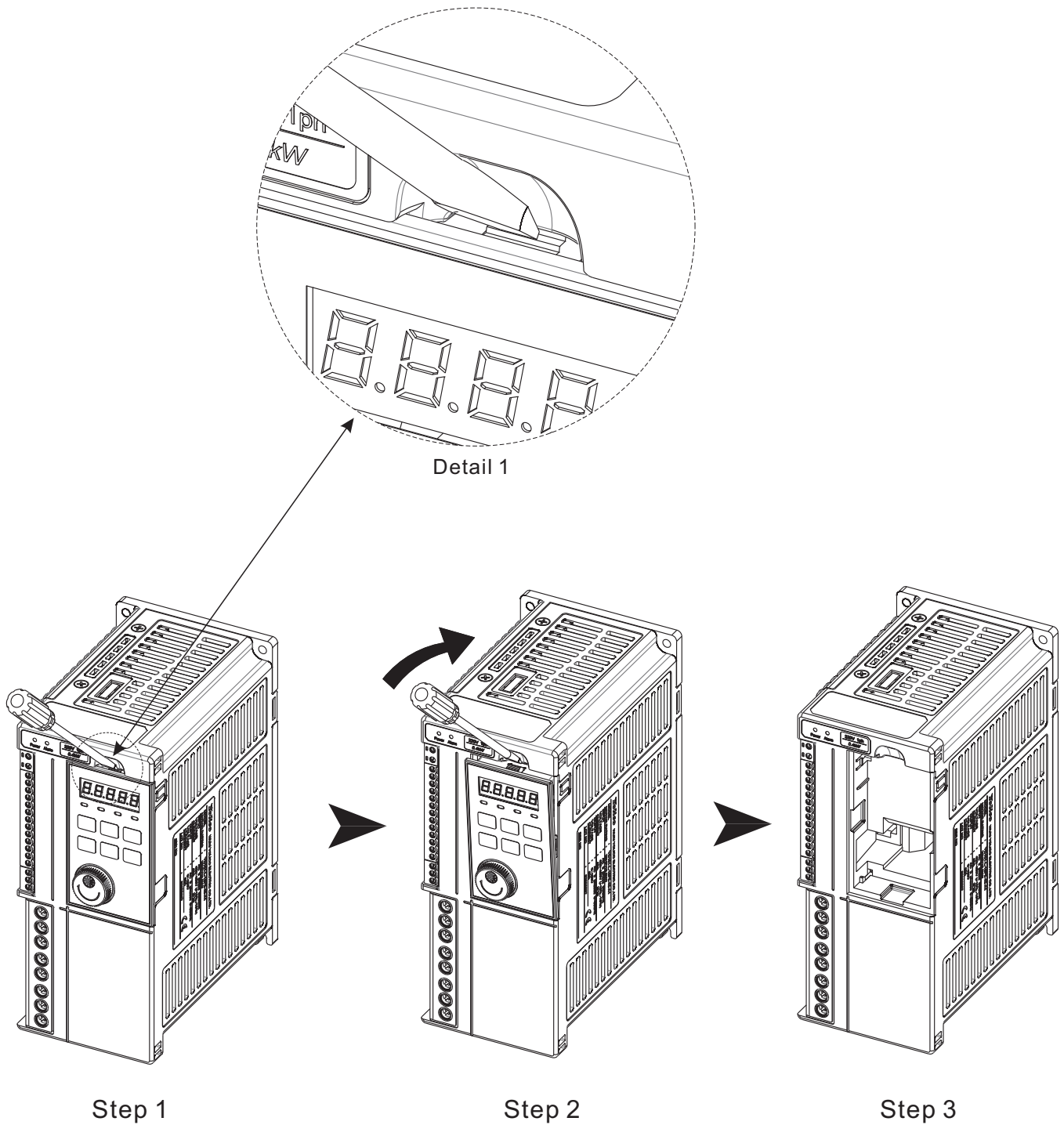

Removing Procedure:

- Step 1: Stick a Slotted Screwdriver in the Groove on Top of Operator as Detail 1, approximately 45 Degrees with the Operator.
- Step 2: Slight tilt Screwdriver to Snap the Retaining Clip, please do not make it broken.
- Step 3: Pull Operator out then Remove it.

Note:

The Screwdriver must be in Right Position when Stuck in the Groove.

3. Wiring & Terminals

3.1 All Electrical Wiring Terminals Diagram

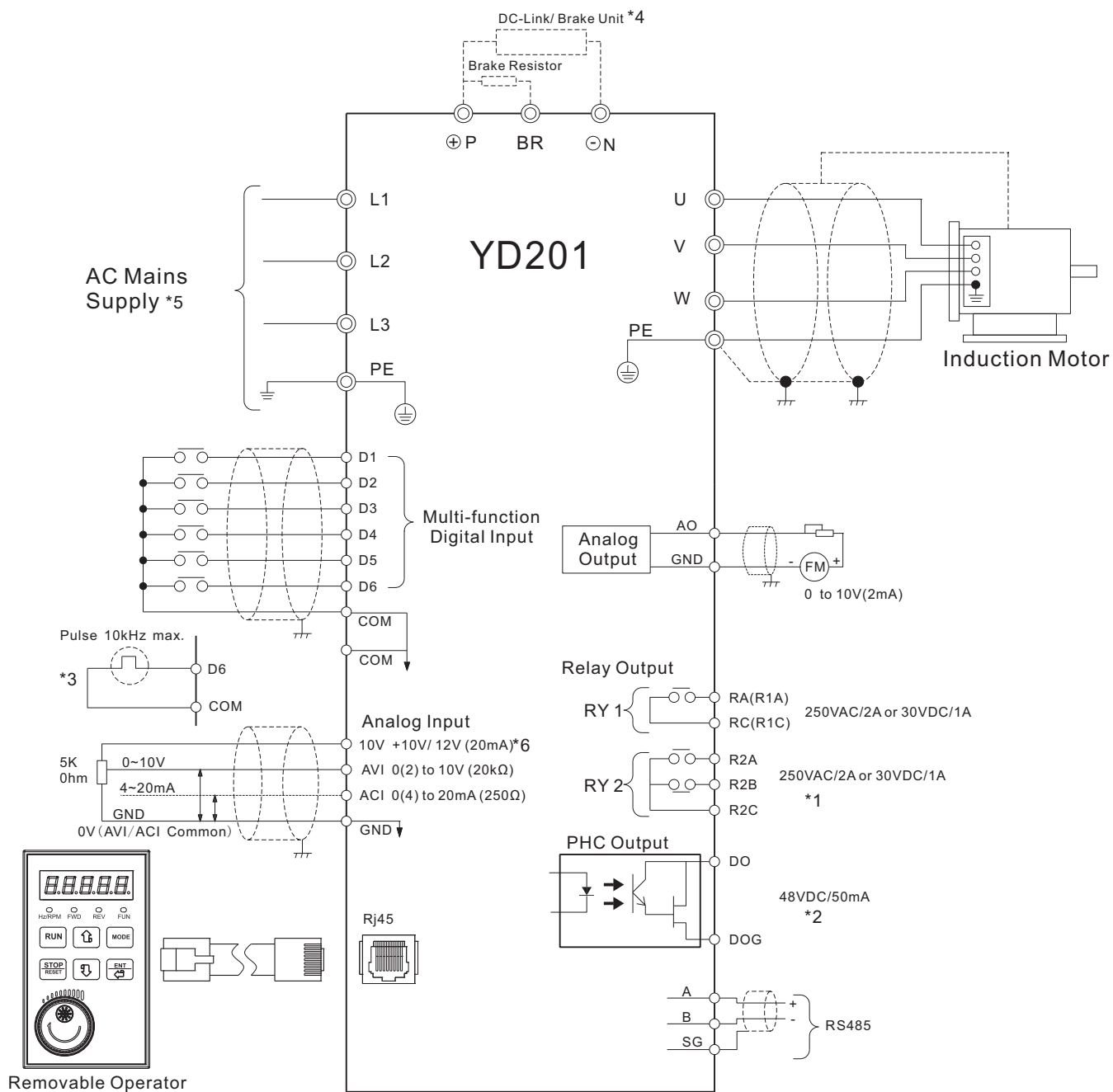

0.4~22kW

连接图 (30KW(含)以上)

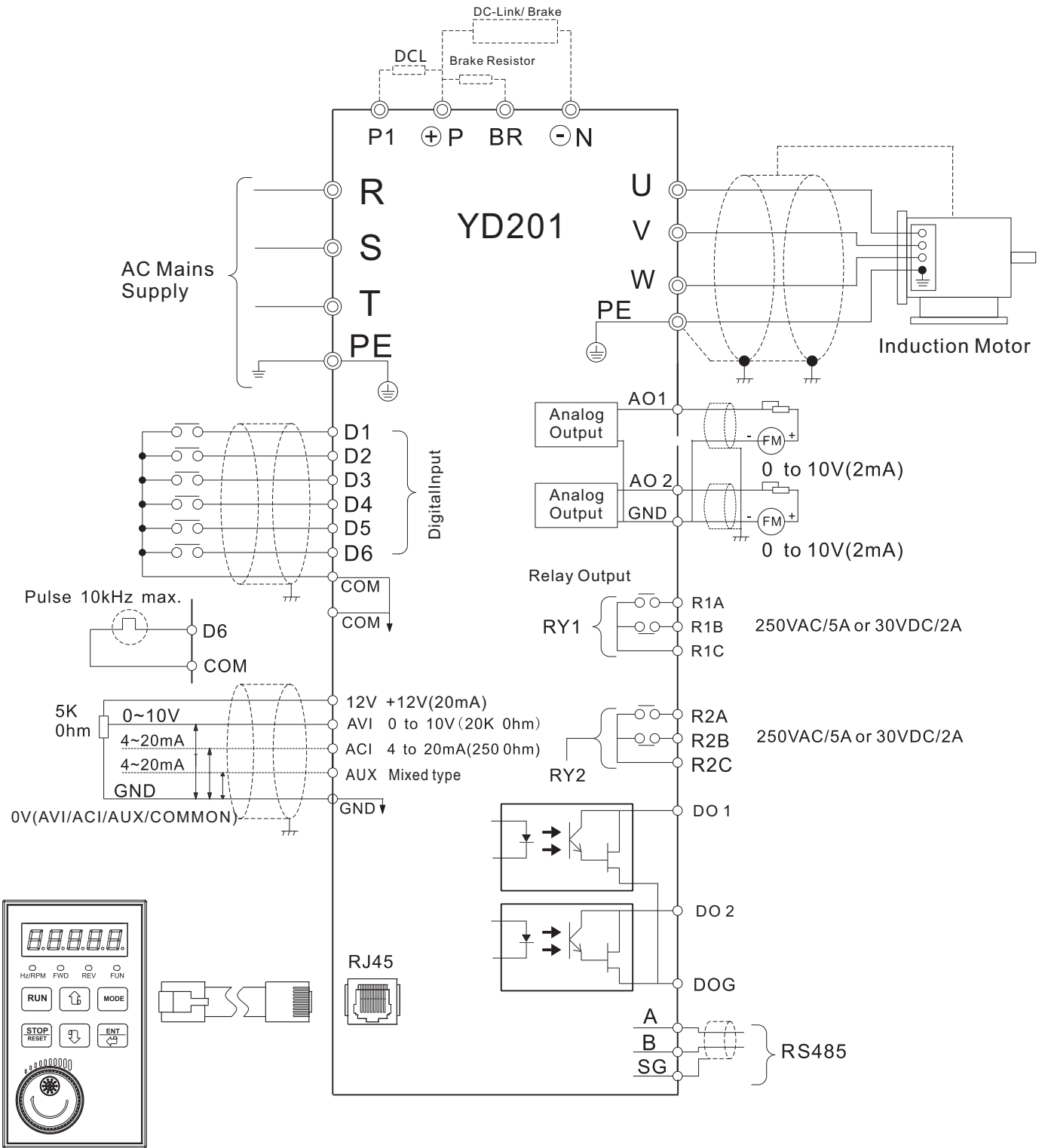

Removable Operator

30~710kW

3.2 Mains Circuit Terminals Description

Symbol	Terminals Description
L1	Mains Power Input 1Ø: L1, L2 3Ø: L1, L2, L3
L2	
L3	
U	3Ø Motor Output
V	
W	
P	P & BR: External Brake Resister connection P/ N: External Brake Unit or DC-Link connection
BR	
N	
⊕	Grounding or Earth

3.3 Mains Terminals Configuration

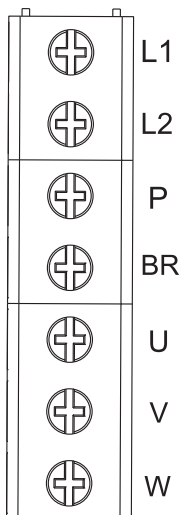

Size A (A1/A2)
200V (0.4~ 2.2kW)

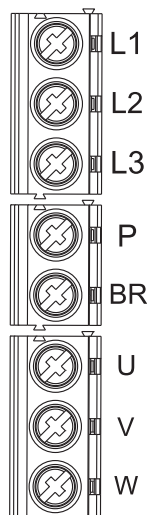

Size A (A1/A2)
400V (0.4~ 3.0kW)

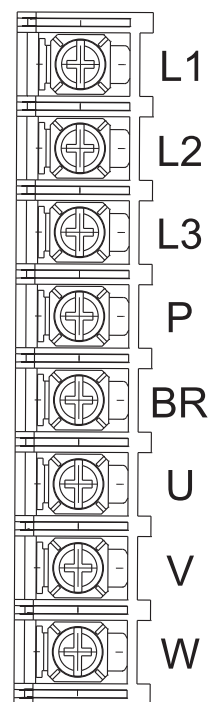

Size B
400V, (4.0~ 5.5kW)

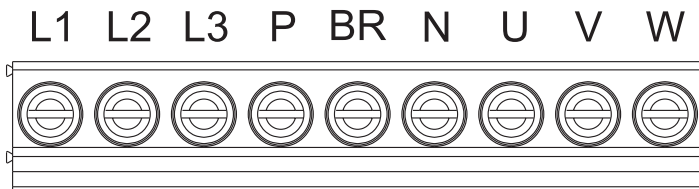

Size C 400V (7.5~ 11kW)

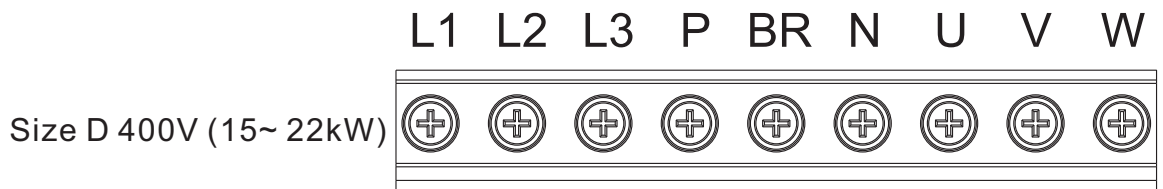

Size D 400V (15~ 22kW)

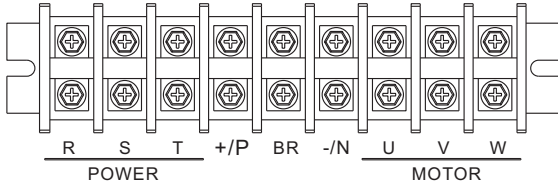

Size E(380V)(30kW)

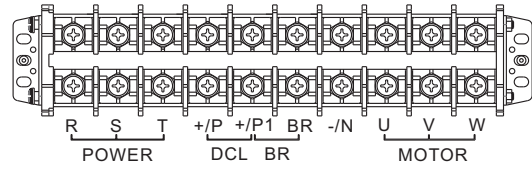

Size F(380V)(37~75kW)

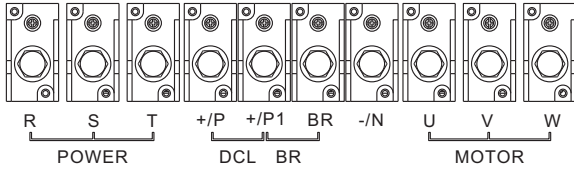

Size G(380V)(93~132kW)

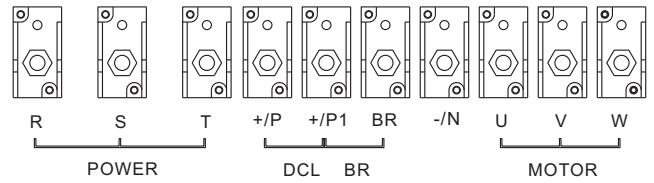

Size H(380V)(160kW)

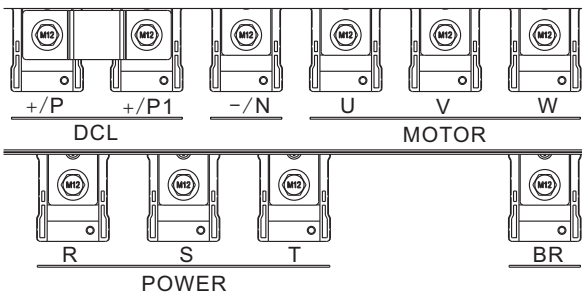

Size I (380V) (185~250kW)

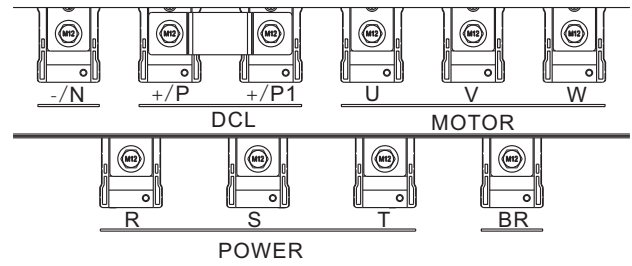

Size J(380V)(280~355kW)

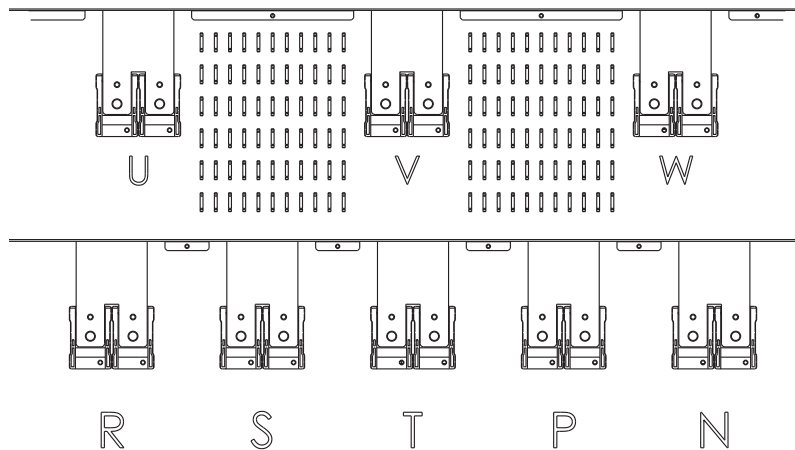

Size K/L(380V)(400~710kW)

3.4 Control Terminals Description

Symbol	CTL Terminals Description	
RA(R1A)	Multi-function Relay Output 1 (RY1) Rating: 250VAC/ 2A or 30VDC/ 1A	RA/RC:0.4~2.2kW/220V 0.75~3.0kW/380V R1A/R1B/R1C:3.7/220V 4.0~710kW/380V
R1B		
RC(R1C)		
R2A	Multi-function Relay Output 2 (RY2) Rating: 250VAC/ 2A or 30VDC/ 1A	30~710kW/380V
R2B		
R2C		
COM	Common of D1~D6	
D1	Multi-function Digital Input Logic: NPN	
D2		
D3		
D4		
D5		
D6		
COM	Common of D1~D6	
10V(12V)	Analog REF PWR Supply, Rating: 20mA Max. 10V for T2S, 12V for T4	
AO/AO1/AO2	Analog Output for Frequency Meter, Rating: 10VDC/2mA	
GND	Analog Signal Common, for AVI/ ACI/ AO	
AVI	Analog Voltage Reference Input, Rating: 0/2~10VDC	
ACI	Analog Current for PID Feedback or REF Bias Input, Rating: 0/4~20mA	
AUX	Mixed type Analog Input :0~10VDC/0~20mA	
DO/DO1/DO2	(+)	Multi-function Photo-Coupler (PHC), Rating: (DC 48V/ 50mA)
DOG	(-)	
A	(+) RS485	Serial Communication Port
B	(-) RS485	
SG	Shielding for Serial Com.	

3.5 Control Terminals Configuration

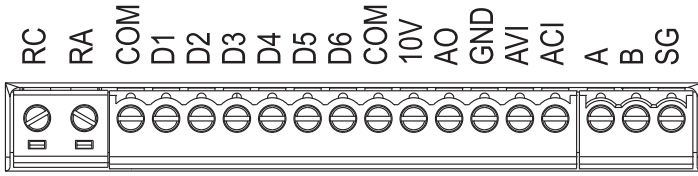

Size A(A1/A2) { 200V:0.4~2.2kW
400V:0.4~3.0kW

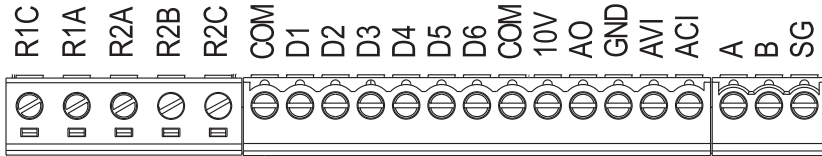

Size B 400V:4.0~5.5kW

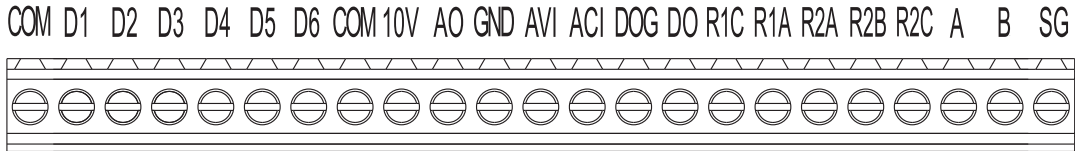

Size C & D 400V:7.5~22kW

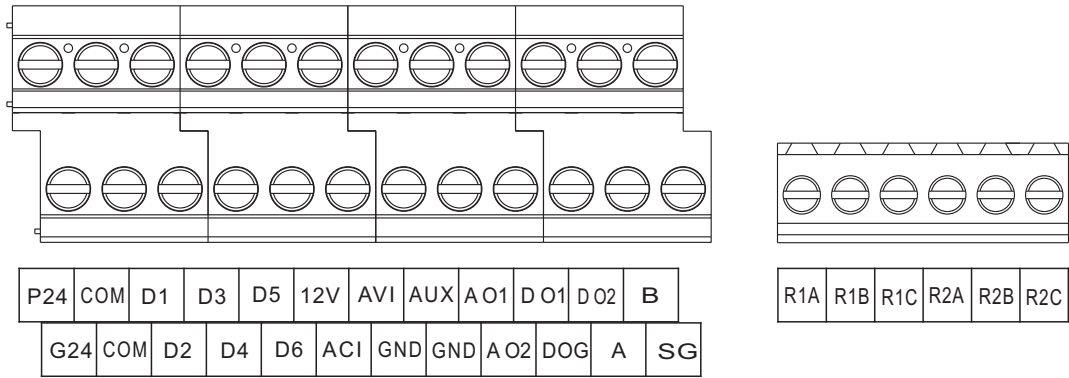

Size E~L (380V: 30~710kW)

3.6 Terminal Tightening Torque and Cable Size in Installation

Frame Size	Mains/ Motor/ DC-Link/ Brake/ Earth			Control		
	Cable Cross Section Range [AWG (mm ²)]	Torque		Cable Cross Section Range [AWG (mm ²)]	Torque	
		N-m	lbf-in		N-m	lbf-in
A(A1/A2) (200V)	20~9AWG(0.5~6mm ²)	1.37	12	25~15AWG (0.14~1.5mm ²)	0.1 9	1.68
A(A1/A2) (400V)	20~10AWG(0.5~5.5mm ²)	1.37	12			
B	20~8AWG(0.5~10mm ²)	1.4	12.4			
C	13~5AWG(2.5~16mm ²)	1.4	12.4	25~13AWG (0.14~2.5mm ²)	0.5	4.4
D	13~4AWG(2.5~22mm ²)	1.4	12.4			

Note All Cabling must comply with National and Local Regulations on Cable Cross-Sections and Ambient Temperature. Copper Conductors required, 60-75°C is recommended.

3.7 Wiring Regulation

a) Mains Connection

Be sure to connect AC Power to the Mains Terminal L1, L2, L3 (1Ø 200V: L1, L2), connect Motor Lead to Output Terminal U, V, W.

! The VFD will damage if connect Output Terminal (U, V, W) to Power.

Tip Connect VFD to an Individual Power Circuit.

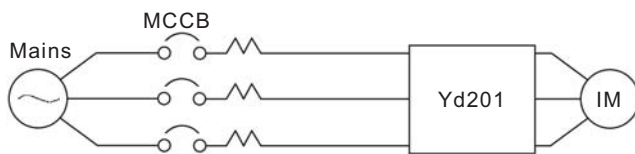

Tip If VFD connected to a Power Circuit with other Devices, please fit a Noise Filter or an Isolated Transformer to eliminate Noise Transmitted between VFD and the Mains Power Line.

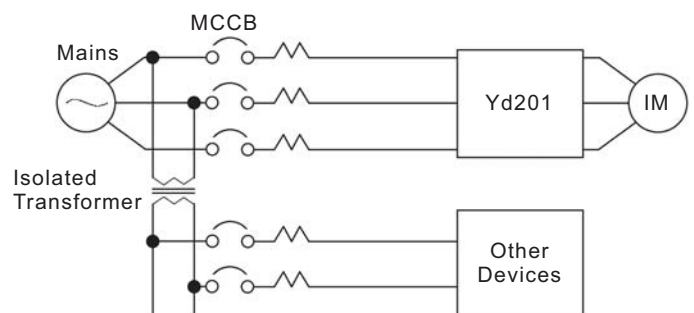
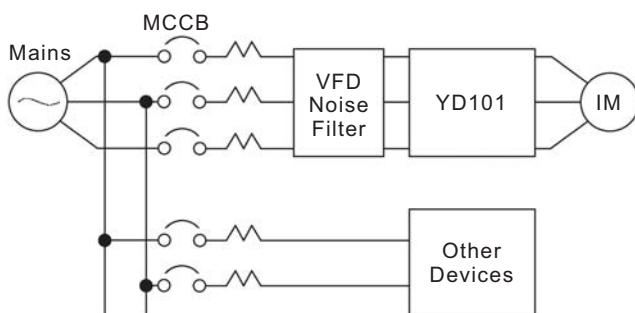

b) Control Connection

Be sure to connect CTL Circuit to the CTL Terminals.

1. All Signal Lines of Control Circuit must not be Longer than 50m and must be Separated from the Mains and Motor Cables, such as L1, L2, L3, U, V, W, P, N, BR.
2. Use a suitable Dimension Screened or Twisted-pair Cables for Control Circuits/ Frequency Reference to prevent VFD Malfunction, the Copper Conductors Cable required, 60-75°C is recommended.
3. Process the Ends of Screened/ Screened Twisted-pair Cable as Figure below.

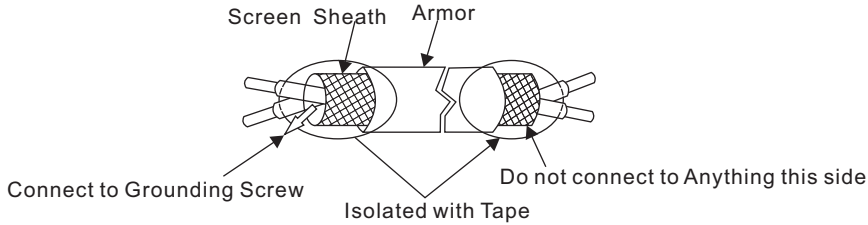

- Tip**
1. Processing the ends of Screen and connect one side Screened part to Screw Grounding.
 2. Do not use the soldered Cable Lead, it would make CTL Signal malfunction.
 3. The Stripping Lengths for CTL Cable is 5.5 mm if no Pin Terminals used.

Size of Pin Terminals

Cable Size	Specification	D1	D2	Manufacturer
0.5mm ²	A10.5-8WH	1.00	2.60	Phoenix Contact
0.75mm ²	A10.75-8GY	1.20	2.80	
1.0mm ²	A11-8RD	1.40	3.00	
1.5mm ²	A11.5-8BK	1.70	3.50	

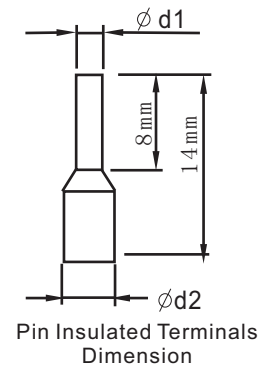

- Note**
1. Do not Solder the Cable Lead if no Pin Terminals using.
 2. The Cable Lead may break by Vibration if soldered.

■ Wiring Procedure

Follow the Procedure below to fit Wire into CTL Terminal.

1. Loose the Screw by a Slotted Screwdriver.
2. Stick the Wire through Bottom of Terminal Strip.
3. Tighten the Screw.

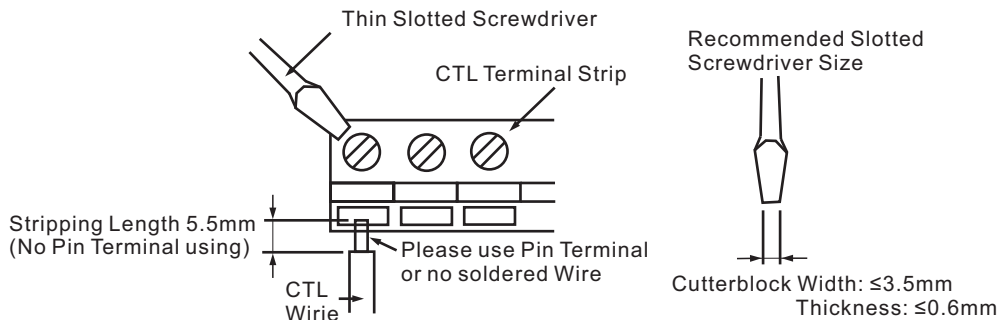

Fit CTL Wire into Terminal Strip

4. LCP Introduction

4. 1 Brief Functions of LCP

The Local Control Panel (LCP) is a Removable Operator, it named as Operator, Keypad, Digital Operator in this Manual.

Hereby introduces the Keys/ Functions of LCP with default Display status after VFD Powered up.



- 5 off 8 Segments Display LEDs
Displays Set Values of Parameter, Parameter Groups or Motoring Values/ Data such as Output Frequency, Current, Voltage, Fault Code or Fault Log.
- Indicator LEDs
Hz/RPM: Illuminates when Motoring Frequency at RPM Scale
FWD: Illuminates at Forward Command
REV: Illuminates at REV Command
FUN: Illuminates when selecting Parameter Mode
- Keys (Buttons)
Totally 6 Keys includes 8 Major Functions of RUN/ STOP/ RESET/ ↑(Increase +)/ ↓(Decrease -)/ MODE/ ENT/ ←(Digit Select).
See Table 4-2 below for Detail Information
- POT (Potential Meter)
The POT works as Frequency Reference if the Reference is set via POT (B1-01=5).
The Max. Value (End of Clockwise Rotating) and Min. Value (End of Counterclockwise Rotating) of POT are corresponding to Frequency Reference Upper Limit (D2-01) and Lower Limit (D2-02).

Table 4-1 Arabic Numeral and English Alphabet correspond to displaying by Segment LED

Numeral	0	1	2	3	4	5	6	7	8	9			
LEDs Display													
Letter	A	B	C	D	E	F	G	H	I	J	K	L	M
LED Display													
Letter	N	O	P	Q	R	S	T	U	V	W	X	Y	Z
LED Display													

Table 4-2 Function of Keys

Key	Name	Function Description
	VFD RUN	<ul style="list-style-type: none"> The VFD runs after depressing if the Command is set via LCP (B1-02=0). The Default Command is via LCP.
	VFD STOP or RESET	<ul style="list-style-type: none"> Stop: VFD normal stop after depressing if the Command is set via LCP (B1-02=0). Fast Stop (E.S.): VFD fast Stop after depressing if the Command is not set via LCP (B1-02≠0). Reset: Depressing to reset Operation after correct the Cause Of Fault.
	↑ (Increment, +)	<ul style="list-style-type: none"> Increasing the Value of Parameter Name, Group or Setting Value.
	↓ (Decrement, -)	<ul style="list-style-type: none"> Decreasing the Value of Parameter Name, Group or Setting Value.
	ENTER or ← (Digit Select)	<ul style="list-style-type: none"> ENTER: Selects Group, Function or Parameter. Displays each Parameter's Set Value. By depressing this Key (after changing a Parameter Setting), the Set Value is Entered. ←: Select a Digit of a Set Value to be changed, the Selected Digit Blinks.
	MODE selection	<ul style="list-style-type: none"> Select the Monitor, Value or Parameter Mode.

4.2 Monitor Display (Ux-XX)

Basically all Monitor Display Ux-xx can be selected no matter what VFD is in Run or Stop Situation.

Monitor Display List

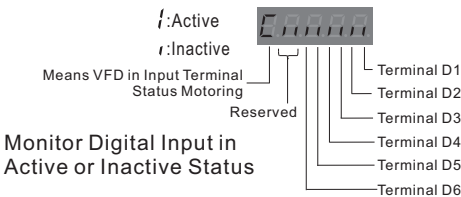
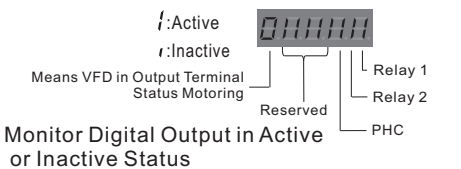
FNC	Parameter NO.	Name	Content	Analog Output Signal	Min. Unit
Status Monitor	U1-01	Frequency REF	Monitor Frequency Reference	10V: Max. Frequency	0.01Hz
	U1-02	Output Frequency	Monitor Output Frequency	10V: Max. Frequency	0.01Hz
	U1-03	Output Current	Monitor Output Current	10V: VFD Rated Current	0.1A
	U1-06	Output Voltage	Monitor Internal Output Voltage Reference	10V: AC(E1-13)	0.1V
	U1-07	DC Bus Voltage REF.	Monitor DC Bus Voltage	10V: DC($\sqrt{2} \times E1-13$)	1V
	U1-10	Input Terminal Status	 <p>Monitor Digital Input in Active or Inactive Status</p>	Disabled	—
	U1-11	Output Terminal Status	 <p>Monitor Digital Output in Active or Inactive Status</p>	Disabled	—
	U1-14	CPU Firmware Number	Manufacturer's ID number	Disabled	—
	U1-15	Terminal AVI Input Voltage % in Frequency REF	Monitors the Input Voltage of the Frequency Reference (AVI). An Input of 10 V corresponds to 100%.	10V: 100% (10V)	0.1%
	U1-16	Terminal ACI Input Current %	Monitors the Input Current of the Frequency Reference or Feedback (ACI). An Input of 20mA corresponds to 100%.	10V: 100% (20mA)	0.1%
	U1-24	PID Feedback	Monitors the Feedback Value when PID Control is used. The Input for the Max. Frequency corresponds to 100%	10V: Max. Frequency	0.1%
	U1-46	IGBT Temperature	Monitors the VFD's IGBT Temperature	Disabled	—
	U1-47	Counter Present Value	Monitors the Counter's Present Value	Disabled	—
	U1-48	Worked Time 1	Monitors the VFD Worked Time1 (Hours)	Disabled	1 Hour
U1-49	Worked Time 2	Monitors the VFD Worked Time2 (Days)	Disabled	1 Day	
Fault Log	U3-01	Most Recent Fault	Monitors the Recent Fault Code	Disabled	—
	U3-02	2 nd Most Recent Fault	Monitors the 2 nd Recent Fault Code	Disabled	—
	U3-03	3 rd Most Recent Fault	Monitors the 3 rd Recent Fault Code	Disabled	—

4. 3 Operation via the LCP

4.3.1 The Display

In Actual Frequency Outputs
LED Fully Lit while VFD Running



In Frequency Reference
LED Blinks while VFD Stopping



In Frequency Setting LED
Blinks while change Value
of selected Digital



- Displayed VFD in Stopping Status

It shows the Frequency Reference, all LEDs are Blinking. At this moment depress the ↑ or ↓ Key could change the Frequency Reference Value. The Blinking Digital will move by depress the ←/ENT Key. The Display will show Frequency Reference again after wrote-in the Set Value by depress the ←/ENT Key for a while or 5 Seconds later if the ←/ENT Key is not depressed.

- Displayed VFD in Operating Status

It shows the Actual Frequency, all LEDs are Fully Lit. At this moment depress the ↑ or ↓ Key could change the Frequency Reference Value. The Blinking Digital will move by depress the ←/ENT Key. The VFD Outputs and Display shows the changed Actual Frequency Value by depress the ←/ENT Key for a while during the VFD is Operating.

4.3.2 Functions of LED Display

8Segment LED Display	Description
	Displays Setting Frequency while VFD is in Stopping. Displays Outputting Frequency during VFD is in Operating.
	Displays Parameter Number
	Displays Value (Setting Value/ PID Feedback...etc)
	Displays AC Voltage
	Displays Output Current
	Displays DC Bus Voltage
	Displays Heat Fin Temperature
	Fault Occurred, refer to 6. VFD Warning/ Alarm Condition, the Possible Cause of Problem
	Displays AVI Value (AVI is in 100%)

4.3.3 ↑ Increment/ ↓ Decrement Functions Structure

↑ Increment/ ↓ Decrement

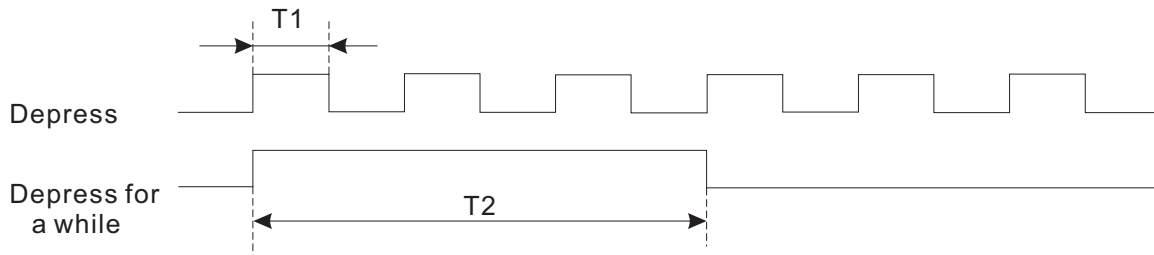

Note The Value of selected Digital just changed by Unit Value if depress the Key. The Value will be continue changed after depress for a while.

4.3.4 LCP Operating Example

- Modify Value for Parameter

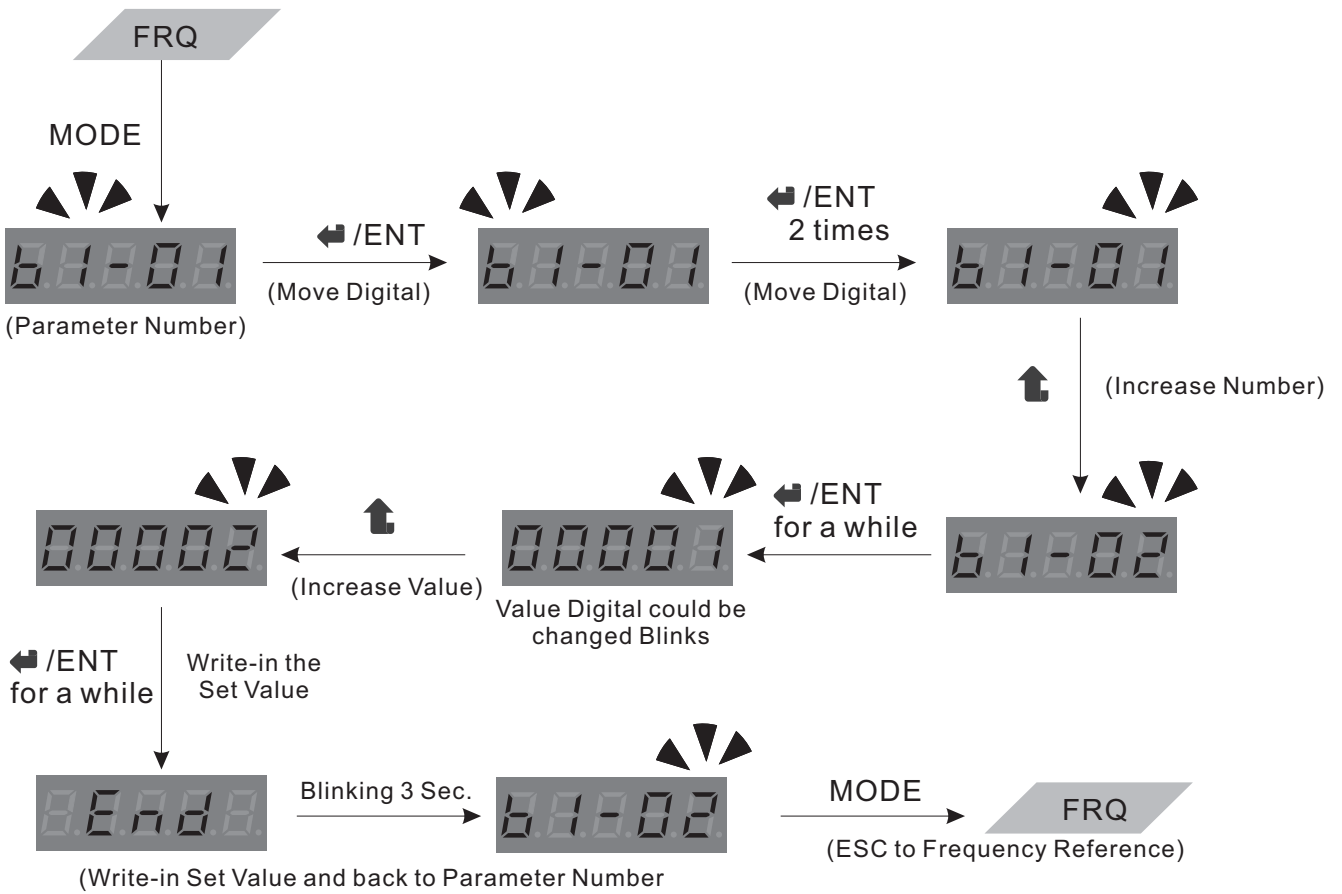

• Change Frequency Reference when VFD in Stops / Operates

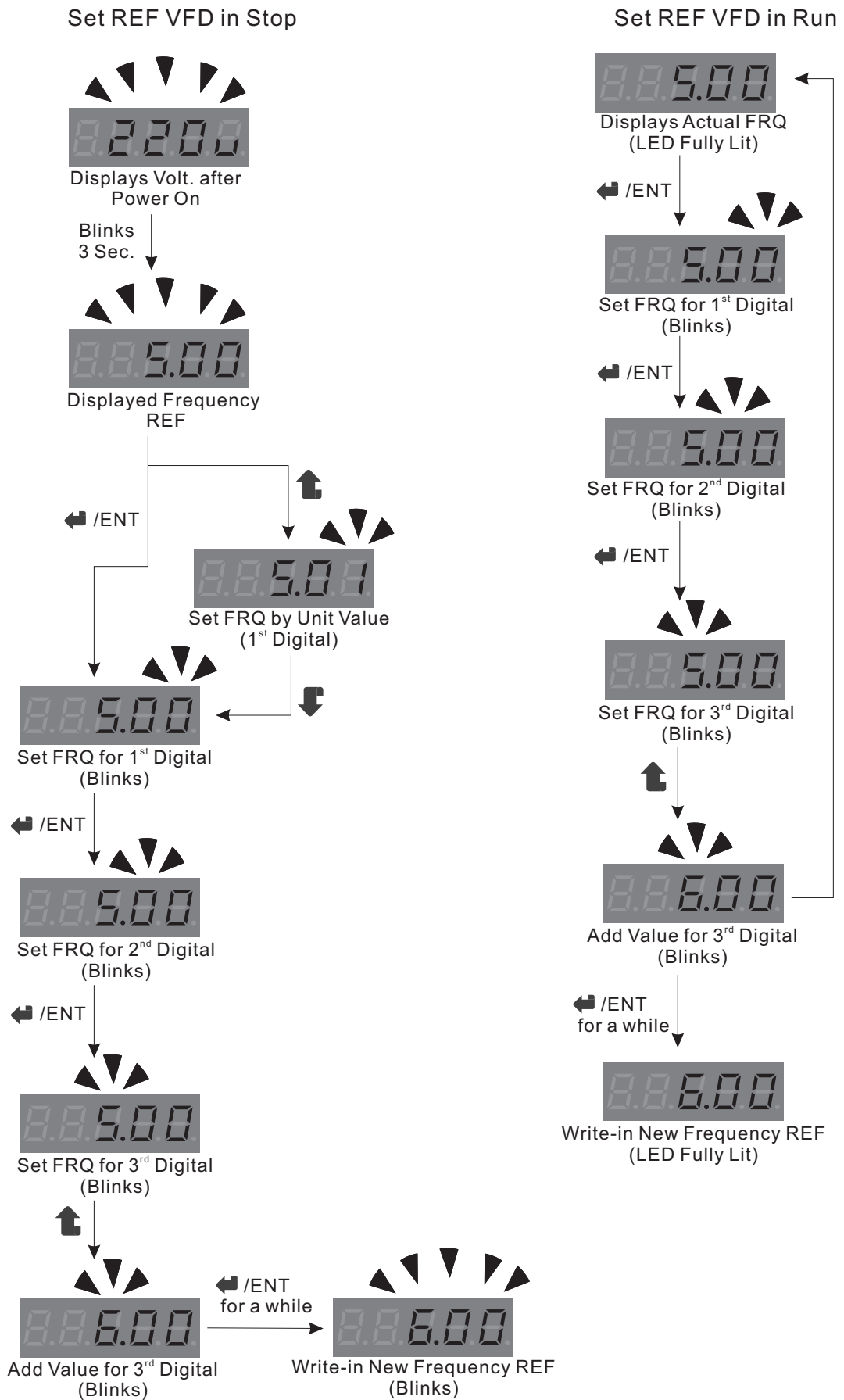

Note

Set the Frequency Reference when VFD in Stop Status, if depress the Key let the Value over than Frequency REF Upper Limit, the Reference Value will increase from Frequency Lower Limit and vice versa

4.3.5 Command and Reference Relation

(Take 3 Wires Control as Example)

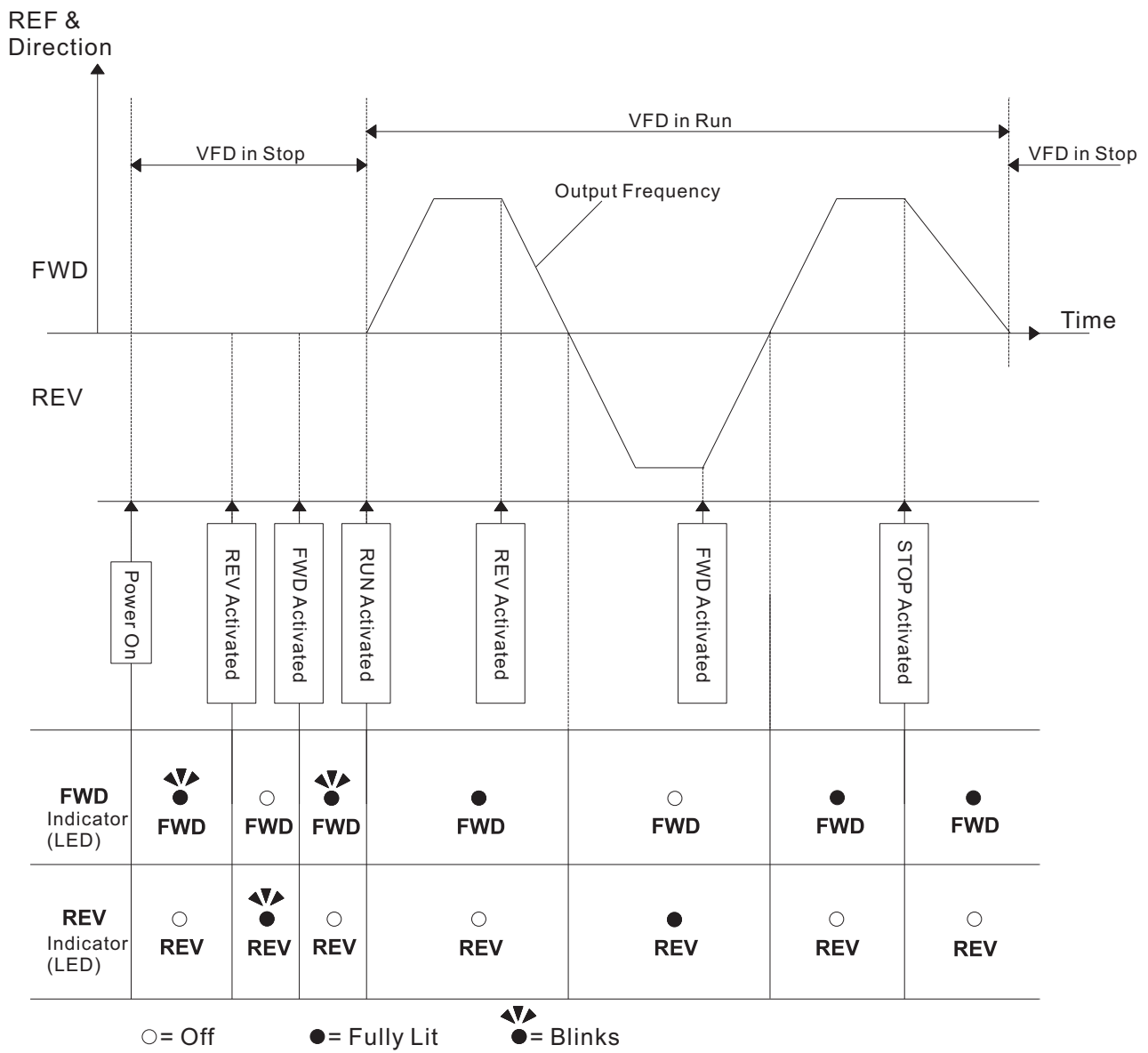

5. Parameter Introduction

5. 1 Parameters Reading

Use the following Key to determine which Control Mode, Detail Information and Access Level are Available for each Parameter in this Manual.

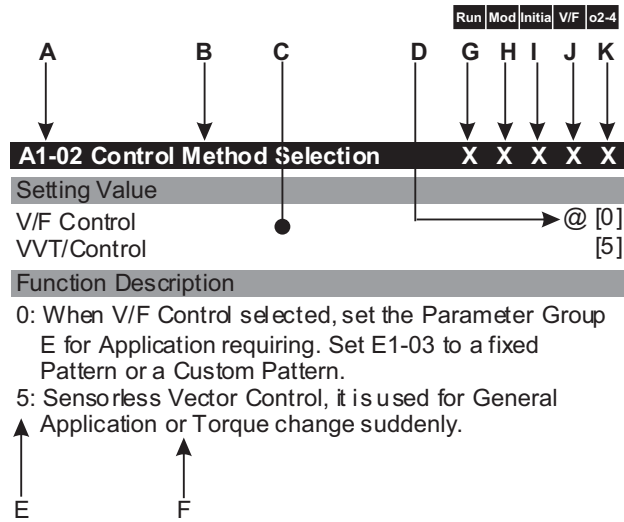

■ Reading Instruction

- A: Parameter Number
- B: Name of Parameter
- C: Set/ Select Value and Name, some Parameter may show Unit in the Bracket after the Setting Range.
- D: Default Value or Setting
- E: Parameter Setting or Selecting Value
- F: Description of Setting or Selecting Value
- G to K: Limit Condition for Parameters
 - G: **Run** This Parameter can be changed during VFD is Operating.
 - H: **Mod** This Parameter can be changed during Serial Communication is Transmitting.
 - I: **Initia** This Parameter becomes Default Value if Parameters Initialized.
 - J: **V/F** This Parameter is limited for V/F Control.
 - K: **o2-4** This Parameter will be changed if Re-set Inverter Model (O2-04)

And meaning of Mark

“O” for YES

“X” for NO

5. 1.1 Parameters List

Group	Function	Page
U (Monitoring)	U1 (Status Monitor)	4-2
	U3 (Fault Log)	
B (Application)	B1 (Sequence)	5-4
	B2 (DC Braking)	5-6
	B3 (Speed Search)	5-6
	B5 (PID Control)	5-7
C (Tuning)	C1 (C1 ACC/DEC Time)	5-11
	C2 (S-Curve ACC/DEC)	5-11
	C3 (Motor Slip Compensation)	5-12
	C4 (Torque Compensation)	5-12
	C6 (Carrier Frequency)	5-12
D (Reference)	D1 (Preset References)	5-13
	D2 (References Limits)	5-16
	D3 (Jump Frequencies)	5-17
E (Motor)	E1 (V/F Pattern)	5-18
	E2 (Motor Set-up)	5-22
	E6 (Operation Direction Definition)	5-22
H (Terminal)	H1 (Digital Inputs)	5-23
	H2 (Digital Outputs)	5-29
	H3 (Analog Inputs)	5-32
	H4 (Analog Outputs)	5-35
	H5 (Serial Communication Set-up)	5-36
L (Protection)	L1 (Motor Overload)	5-38
	L2 (Power Loss Ridethrough)	5-39
	L3 (Stall Prevention)	5-40
	L4 (Reference Detection)	5-42
	L5 (Automatic Restart)	5-42
	L6 (Over Current Detection)	5-44
	L8 (Hardware Protection)	5-44
O (Opertaor)	O1 (Monitor Selection)	5-45
	O2 (Key Selection)	5-45
P (Process)	P1 (Auto Process Operation)	5-47
T (VVT Adjusting)	T1 (Motor Nameplate Data)	5-51
	T2 (Motor Adjusting Constants)	5-51

5.2 Initialization, Group (A)

5.2.1 Initialization Set-up: A1

A1-02 Control Method Selection X O O X X

Setting Value

V/F Control @ [0]
VVT Control [5]

Function Description

[0]: When V/F Control selected, set the Parameter Group E for Application requiring. Set E1-03 to a fixed Pattern or a Custom Pattern.

[5]: **V**ariable **V**ector **T**orque (VVT), it is used for General Application or Torque change suddenly.

A1-03 Initialize Parameter X O O X X

Setting Value

No Initialize @ [0]
Factory Initialize (50Hz) [1150]
2 Wires Control Initialize (50Hz) [2250]
3 Wires Control Initialize (50Hz) [3350]
Factory Initialize (60Hz) [1160]
2 Wires Control Initialize (60Hz) [2260]
3 Wires Control Initialize (60Hz) [3360]

Function Name

Initialize Parameters

Function Description

- Set Value to “_ _ 50” Initializes the Parameter to 50Hz System, “_ _ 60”. Initializes the Parameter to 60Hz System.
- Set Value to “11_0” Initializes the Parameter to Factory Default, then B1-01/ B1-02= 0 (LCP) Automatically.
- Set Value to 22_0 Initializes the Parameter to 2 Wires Control, the Set B1-01= 0 (LCP) / B1-02= 1 (Terminals) and B1-11= 1 (RUN/ STOP and FWD/REV) Automatically.
- Set Value to 33_0 Initializes the Parameter to 3 Wires Control, the Set B1-01= 0 (LCP) / B1-02= 1 (Terminals) and B1-11= 2 (RUN, STOP and FWD/REV) Automatically.

Note:

- When 2 Wires or 3 Wires Control Initialized, the Parameters will be set H1-01= 80, H1-02= 81, and that no needs to change.
- When 3 Wires CTL Initialized, the Terminal D3 will be defined to “FWD/ REV Selection” Automatically, the Parameter H1-03 can be set but it is Unavailable

A1-04 Parameter Password X O O X X

Setting Value

0~ 65535 @ 00000

Function Name

Password Protection Setting

Function Description

This Parameter allows the Password Lock-out Parameters as Selection in O2-11, this Parameters A1-04 can be accessed to Key-in. All or some other Parameters cannot be changed. Please see Parameter O2-11 on Page. 5-46 for more Information.

Use the following Procedure to Set the Password to Lock-out and Unlock-out Protection.

- Set Password to Lock-Out
 - Get into Parameter A1-04, the Display must show “0000”, enter a Password you want. Depress the Enter Key a few seconds, the Display shows “End”.
 - Get into this Parameter again, the Display will show “0001”, enter the Password as Step1. Depress the Enter Key a few seconds, the Password Lock-out is success if Display shows “LOC”.
If the Passwords are different from Step1 to Step2, Display shows “OPE02”, Password Lock-out is fail.

- Unlock-out

Get into Parameter A1-04, the Display must show “0002”, enter the Right Password then depress the Enter Key a few seconds, the Display shows “End” if Unlocked. If the Unlock-out Password is Incorrect, Display shows “LOC”. (VFD is still in Lock-out situation)

Note:

The VFD is in Unlock-out, if A1-04=“0000”.

5.3 Application, Group (B)

5.3.1 Sequence: B1

B1-01 Reference Source Selection X O O X X

Setting Value

LCP MOPs	@ [0]
Terminals	[1]
Serial Communication	[2]
Pulse Train/PWM Input (D6)	[4]
POT	[5]
Terminal MOPs	[6]

Function Name

Frequency Reference Source Selection

Function Description

Please Set to "1" if the Reference is via Control Terminals AVI or ACI .

MOP: **M**otor **O**perated **P**otentiometer

POT: Potential Meter of Operator.

[6]: Please set 2 Digital Input Terminals to MOP Functions (H1-__=10 & 11) if Reference Source via Terminal MOPs

B1-02 Run CMD Source Selection X O O X X

Setting Value

LCP Keys	@ [0]
Terminals	[1]
Serial Communication	[2]

Function Name

Operation Command Source Selection

Function Description

Please Set the Command Source match to your Device. If it is set to Terminals, the 2 Wires or 3 Wires Control can be Set by B1-11 (Terminal Control Selection) or A1-03 Initialization. See A1-03 and B1-11 for more Detail.

B1-03 Stopping Method Selection X O O X X

Setting Value

Ramp to Stop	@ [0]
Coast to Stop	[1]

Function Description

This Function selects the Stopping Method suitable for the Particular Application.

[0]: Decelerating Stop according to the Deceleration Time.

[1]: Free Run to Stop.

B1-04 Reverse Operation X O O X X

Setting Value

Reverse Run Enable	@ [0]
Reverse Run Disable	[1]

Function Name

Prohibition of Reverse Operation

Function Description

A "Reverse Run Disabled" setting does not allow a Reverse Run Command from the Control Circuit Terminal or LCP. This setting is used in Applications

B1-06 Number of Input Scan X O O X X

Setting Value

1~ 100	@ 5
--------	-----

Function Name

Number of CTL Sequence Input Scan Setting

Function Description

This Parameter selects the Number of Scan for Reading Sequence Input Data from the Control Circuit Terminals D1 to D6. The Scan Time is 2m Second Cycle. In Environment contains the Noise Interfere, Increase B1-06 can defense the obstruction, but the Signal Response should be lower.

■ Stopping Method Description

Ramp to Stop (B1-03=0)

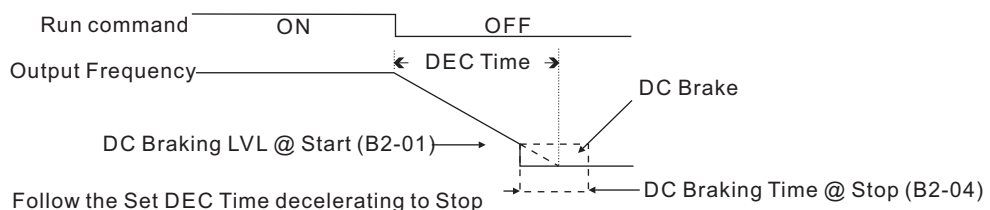

Coast to Stop (B1-03=1)

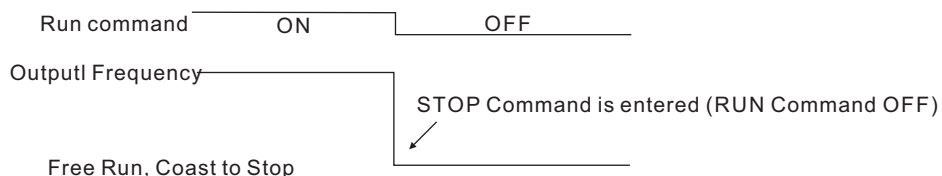

B1-09 Auxiliary Operation Method Selection X O O X X

Setting Value	
LCP MOPs	@ [0]
Terminals	[1]
Serial Communication	[2]
Function Name	
Auxiliary Operation Command Source Selection	

B1-10 Auxiliary Reference Selection X O O X X

Setting Value	
LCP MOPs	@ [0]
Terminals	[1]
Serial Communication	[2]
Pulse Train/PWM Input (D6)	[4]
POT	[5]
Terminal MOPs	[6]
Function Name	
Auxiliary Frequency Reference Source Selection	

B1-12 Auto Voltage Regulation X O O X X

Setting Value	
AVR Enable just VFD in Run	@ [0]
AVR Disable	[1]
AVR Enable in ACC/ Run/ DEC	[2]
Function Name	
Auto Voltage Regulation (AVR) for Output Selection	
Function Description	
AVR Enable is the VFD control PWM to maintain the Output Voltage Stability when Input Voltage Variation	
[0]: AVR is enabled while VFD just in Run Status.	
[2]: AVR is enabled while VFD in ACC, RUN, DEC Status.	

B1-11 Terminal Control Selection X O O X X

Setting Value	
FOR/STOP-REV/STOP	@ [0]
RUN/STOP-FOR/REV	[1]
3 Wires Control	[2]

Function Name
Multifunction Input Terminals Control Method Selection

Function Description

- B1-11 is Enabled after B1-02 or B1-09=1(Terminals)
- The LCP STOP Key can be use for a Auxiliary Stop Key during External Terminal Operation (B1-02 or B1-09=1, please refer to O2-02).
- When B1-02 or B1-09 =0, the VFD Stop if FWD and REV Signal are activated at the same time.

The Terminals Connection and Signal Timing Sequence are Described as below:

a) B1-11= "0"

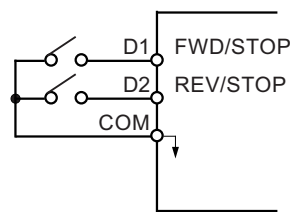

b) B1-11= "1"

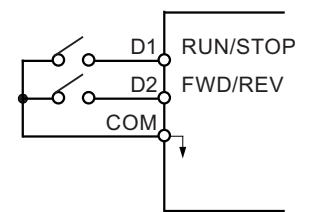

c) B1-11= "2"

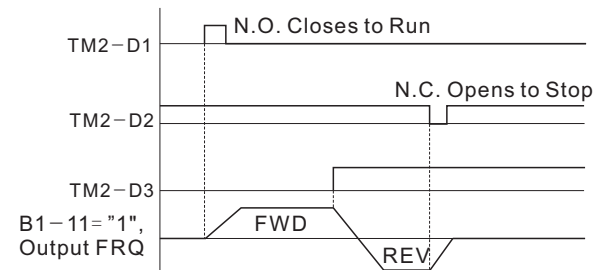
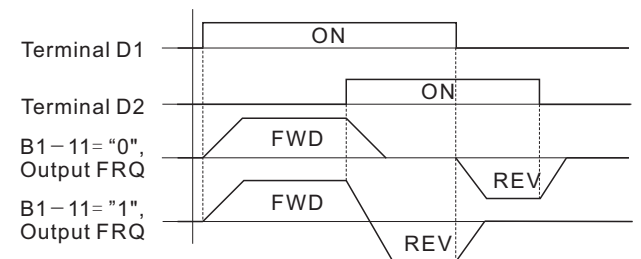
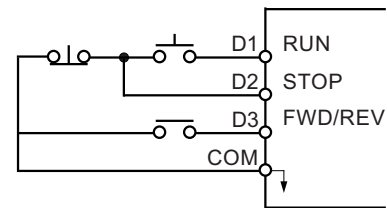

Fig. Terminal Signal Timing Sequence

5.3.2 DC Brake: B2

B2-01 DC Braking Frequency at Stop X O O X X

Setting Value
0.10~ 10.00 (0.01 Hz) @ 1.5

Function Description

Sets the Frequency at which DC Injection Braking Starts, in Units of 0.01 Hz.

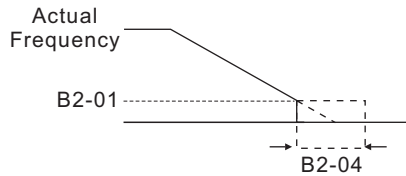

Note: When Coast to Stop is selected as the Stopping Method (B1-03), DC Injection Braking at Stop is Disabled.

B2-02 DC Braking Current at Stop X O O X X

Setting Value
0.0~ 150.0 (0.1 %) @ 50.0

Function Description

DC Injection Braking Current is set as a Percentage of VFD Rated Current. This parameter should not be set unnecessarily High or Motor Over-excitation may occur.

B2-03 DC Braking Time at Start X O O X X

Setting Value
0.0~ 25.5 (0.1 Sec.) @ 0.0

Function Description

DC Injection Braking at Start can be used to stop a Spinning Motor (or when Motor Rotation Direction is unknown) prior to Running. DC Injection Braking Time at Start is set in Units of 0.1 Second. When B2-03 is set to "0", DC Injection Braking is disabled and Acceleration Starts from the Minimum Output Frequency.

B2-04 DC Braking Time at Stop X O O X X

Setting Value
0.0~ 25.5 (0.1 Sec.) @ 0.5

Function Description

DC Injection Braking Time at stop is set in units of 0.1 second.

When B2-04 is set to "0", DC Injection Braking is Disabled, and the VFD Output Shuts OFF.

B2-09 DC Braking Current at Start X O O X X

Setting Value
0.0~ 150.0 (0.1 %) @ 0.0

Function Description

DC Injection Braking Current is set as a Percentage of VFD Rated Current. This parameter should not be set unnecessarily High or Motor Over-excitation may occur.

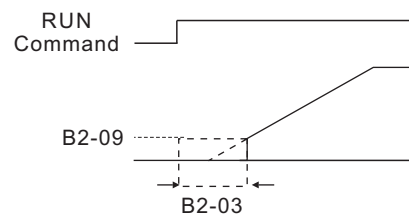

5.3.3 Speed Search: B3

B3-01 Speed Search at Start X O O X X

Setting Value
Speed Search Disable @ [0]
Speed Search Enable [1]

Function Name

Speed Search after Run Command

Function Description

When starting into a Coasting Motor, use the Speed Search Command or DC Injection Braking at Start, to prevent a VFD trip and Motor burnout.

B3-04 Speed Search Mode Selection X O O X X

Setting Value
Speed Search by Unidirectional @ [0]
Speed Search by Bidirectional [1]

Function Name

Detecting the Rotating Direction when Speed Search

Function Description

- [0]: Detect the Rotating Direction based on the Direction of Run Command given.
- [1]: Detect the Motor Speed at any Direction then Speed Up to the Direction as Run Command given.

B3-05 Speed Search ERR Coefficient X O O X X

Setting Value
1~ 8192 @ 250

Function Name

ERR Frequency Coefficient for SPD Search accomplishes

Function Description

Please adjust this Value accords to the Load Inertial. Enlarge the Value if Load Inertial is high Inertial and Reduce the Value if Inertial is low.

The Coefficient Value 8192 is corresponding to Motor Rated Frequency.

5.3.4 PID Control: B5

B5-01 PID Control Mode Selection	X	O	X	X
Setting Value				
PID Disable		@	[0]	
PID Enable (Deviation Signal is put through Deviate Control)			[1]	
PID Enable with Feed Forward (Feedback Signal is put through Deviate Control)			[2]	
PID Enable (Deviation Signal is put through Deviate Control, the Deviate Control with Invert Characteristic)			[3]	
PID Enable with Feed Forward (Feedback Signal is put through Deviate Control, the Deviate Control with Invert Characteristic)			[4]	

Function Description

[1]: D is the variation(Target – Feedback) in the per unit Time(B5-02)
 [2]: D is the Feedback Value in the per unit Time(B5-02)
 [3]: D is the variation(Target – Feedback) in the per unit Time(B5-02) with Invert Feature.
 [4]: D is the Feedback Value in the per unit Time(B5-02) with Invert Feature.

For [1] & [2], when the Target – Feedback is Positive, the Frequency Increase.
 For [3] & [4], the Frequency Decrease when Target – Feedback is Positive and the Frequency Increase when Target – Feedback is Negative.

As Figure PID Control below, Example for Set Value 3 or 4 (Invert Feature)

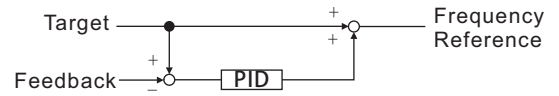

Fig. PID Control Value 3 or 4

■ Purpose for PID Control

Applications using PID Control of the VFD, as shown in the Table below.

● Examples of used PID Control

Application	Control Feature	Detector/ Sensor
Speed Control	<ul style="list-style-type: none"> Operating Speeds are matched to Target Values as Speed Information in a Mechanical System. Speed Information for another Mechanical System is Input as Target Values, and Synchronized Control is executed by Feeding back Actual Speed 	Tachogenerator (0~10V, 0/4~20mA)
Pressure Control	Pressure Information is returned as Feedback for Stable Pressure Control.	Pressure Sensor
Flow Control	Flow Information is returned as Feedback for Accurate Flow Control.	Flow Sensor
Temperature Control	Temperature Information is returned to Control Temperature by turning a Fan.	Thermocouple Thermistor

● Example of used PID Control

In order to Distinguish the Separate PID Control Operations (i.e., Proportional, Integral, and Deviation), Fig. PID Control Operations shows the changes in the Control Input (i.e. the Output Frequency) when the Deviation between the Target Value and Feedback is held Constant.

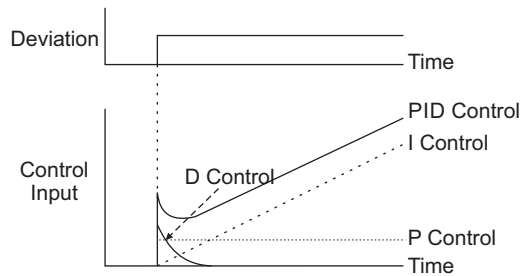

Fig. PID Operation

■ Function of P, I, D and PID

- **Proportional – P Control:** A control Input Proportional to the Deviation is Output. The Deviation can't be Zero by P Control alone.
- **Integral – I Control:** A Control Input which is an Integral of the Deviation is Output. This is effective for matching the Feedback to the Setpoint Value. Suddenly changes, however can't be followed.
- **Derivative – D Control:** A Control Input which is an Integral of the Deviation is Output. Quick response to sudden changes is possible.
- **PID Control:** Optimum Control is achieved combining the best feature of P, I, and D Control.

■ Type of PID Control

Two type of PID Control are possible with the VFD: Measured-Value Derivative PID Control and Basic PID Control. The Type that is Normally used is Measured-Value derivative PID Control. Please refer the Description below:

● **Measured-Value Derivative PID Control:**

With Measured-Value Derivative PID Control, the Feedback Value is Differentiated for PID Control. Response is possible with respect to change both in Setpoint Values and the Control object.

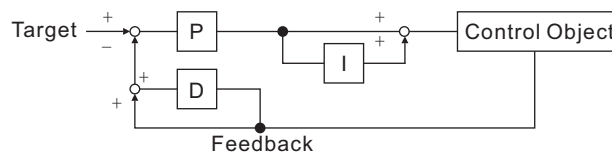

Fig. Measured-Value Derivative PID Control Diagram

● **Basic PID Control:**

This is the Basic form of PID Control. When the D Control Response is adjusted to follow changes in the Control Object, Overshooting and Undershooting can occur with changes in the Setpoint Value.

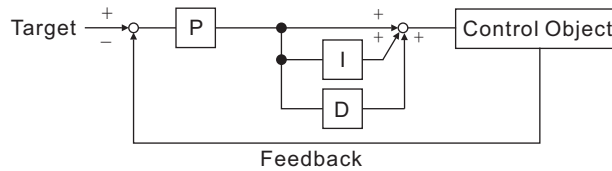

Fig. Basic PID Control Diagram

■ PID Function Block

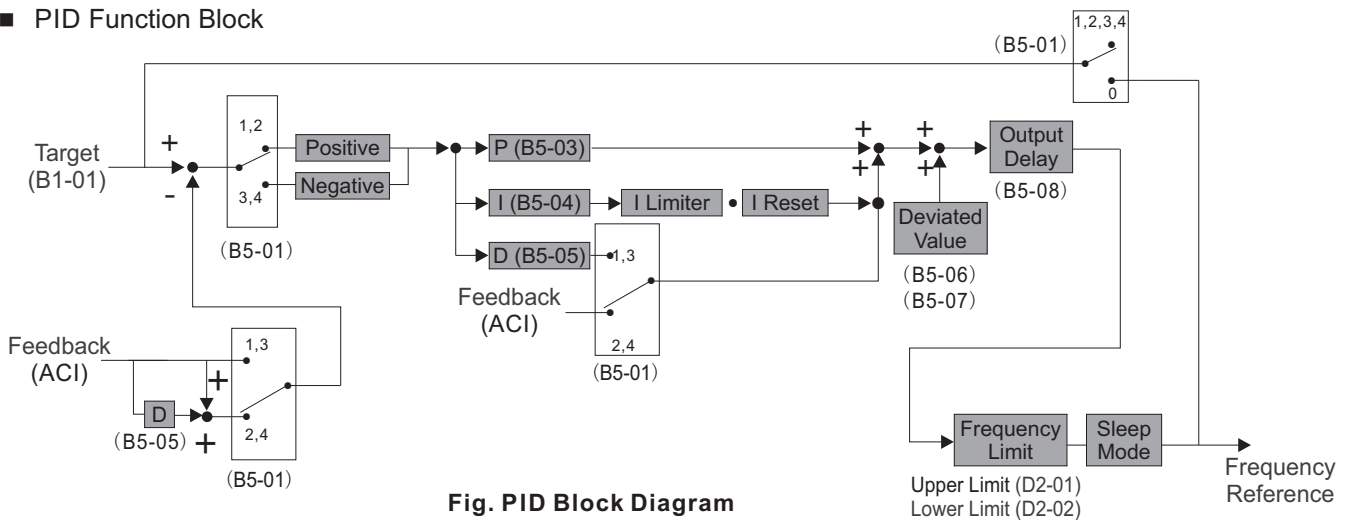

Fig. PID Block Diagram

Note:

1. Runs the PID Control, please set Terminal **ACI** Function Selection to "PID Feedback (H3-09=0).
2. The Set Value of Target (B1-01) in Fig. PID Block Diagram is the Frequency of in B1-01 or B1-10 set.

B5-02 PID Feedback Regulated Gain **O O O X X**

Setting Value

0.00~10.00 @ 1.00

Function Description

B5-02 is the Feedback Proportional Coefficient, the Deviation is equal to (Target - Feedback) X B5-02

B5-03 PID Control Proportional Gain **O O O X X**

Setting Value

0.0~10.0 @ 1.0

Function Description

The Proportional Gain is the Value by which the Deviation Signal is Multiplied to generate a new Frequency Reference.
The PID is not activated if B5-03=0.0

B5-04 PID Control Integral Time **O O O X X**

Setting Value

0.0~100.0 (Sec.) @ 10.0

Function Description

The Integral Calculation sums the Deviation over time, which eliminates the Offset, thus achieving the Intended Value. The Integral Time determines how quickly the Integral Gain increase is added to the Control Loop.

B5-05 PID Control Derivative Time **O O O X X**

Setting Value

0.00~10.00 (Sec.) @ 0.00

Function Description

The Derivative Calculation attempts to control the Remaining Overshoot left over after the Proportion and Integral Calculations.
If the System is approaching the Intended Value very rapidly, the Derivative Control produces a Strong Braking Action to prevent Overshoot.

If the System is already Stable with very Little Deviation change, Derivative Control has very Little Effect.
The Derivative Time is used to dampen Oscillations and reduce Overshoot, thus improving stability. Setting the Derivative Time to a Larger Number produces more Braking Action in the Control System.

B5-06 PID Control Offset +/- Selection **O O O X X**

Setting Value

Positive @ [0]

Negative [1]

Function Name

PID Control Bias Positive/ Negative Selection

Function Description

Set the PID Offset in Positive or Negative Value.

B5-07 PID Control Offset **O O O X X**

Setting Value

0~ 109 (%) @ 0

Function Description

The PID Offset adds a Bias to the Calculated PID Value, in order to reduce any Offset.

Run Mod Initial V/F o2-4

B5-08 PID Control Delay Time **O O O X X**

Setting Value

0.0~2.5 (Sec.) @ 0.0

Function Name

PID Control Output Primary Delay Time

Function Description

The output delay time is used to delay changes in the calculated PID value, which can prevent oscillations and improve stability.

B5-09 PID Feedback Loss Action **X O O X X**

Setting Value

Disabled @ [0]

Warning, VFD keep Operating [1]

Fault, VFD Output Shut Off [2]

Function Description

This Parameter is used to select what Action the VFD will take on a Loss of PID Feedback.

[1]: Warning, the LCP show "FBL" Message only, VFD Keep Operating.

[2]: Fault, the LCP show "FBL" Message and VFD Output Shut Off.

A Loss of PID Feedback occurs when the Feedback Signal falls below the B5-10 FBL Detection Level for the Time set by B5-11 FBL Detection Time.

B5-10 Feedback Loss Detection Level **X O O X X**

Setting Value

0~100 (%) @ 0

Function Description

This Parameter sets the Level at which a Loss of PID Feedback is detected. The Deviation is equal to Target - Feedback, if the Deviation must be at or below this level for the Time defined by B5-11 before a Loss of Feedback can be detected. A Setting of 100% represents 100% of the Feedback Signal.

B5-11 Feedback Loss Detection Time **X O O X X**

Setting Value

0.0~25.0 (Sec.) @ 1.0

Function Description

See B5-10 and B5-11

B5-12 PID Control Integral Limit **O O O X X**

Setting Value

0~109 (%) @ 100

Function Description

The Integral Limit Value eliminates Oscillations and improves Stability. This Value is set as a Percentage of Maximum Output Frequency (E1-04).

B5-14 PID Sleep Frequency X O O X X

Setting Value

0.00~650.00 (Hz) @ 0.00

Function Description

If the PID Output is equal to or less than B5-14 set Value for the Time set by B5-15 PID Sleep Delay Time, the VFD will go to Sleep.

B5-15 PID Sleep Delay Time X O O X X

Setting Value

0.0~25.0 (Sec.) @ 0.0

Function Description

If the PID Output is equal to or less than B5-14 set Value for the Time set by B5-15 PID Sleep Delay Time, the VFD will go to Sleep.

B5-16 PID Wake Up Frequency X O O X X

Setting Value

0.00~650.00 (Hz) @ 0.00

Function Description

The PID Wake-up Level B5-16 and Wake-up Delay Time B5-17 are related to the Reference when VFD should Wake-up or Start again.

Run Mod Initial V/F o2-4

B5-17 PID Wake Up Delay Time X O O X X

Setting Value

0.0~25.0 (Sec.) @ 0.0

Function Description

PID Sleep Mode is activated when to meet all Conditions below:

- B5-01≠ 0 (PID Enabled)
- H3-09= 0 (PID Feedback Enabled)
- B5-14 PID Sleep Frequency, unit as Hz
- B5-15 PID Sleep Delay Time, unit as Second
- B5-16 PID Wake Up Frequency, unit as Hz
- B5-17 PID Wake Up Delay Time, unit as Second

When the PID Output is equal to or less than B5-14 set Value for the Time set by B5-15 PID Sleep Delay Time, the VFD Output will Shut off then go to Sleep.

If the PID Output is equal to or more than B5-16 set Value for the Time set by B5-17, the VFD will Wake Up.

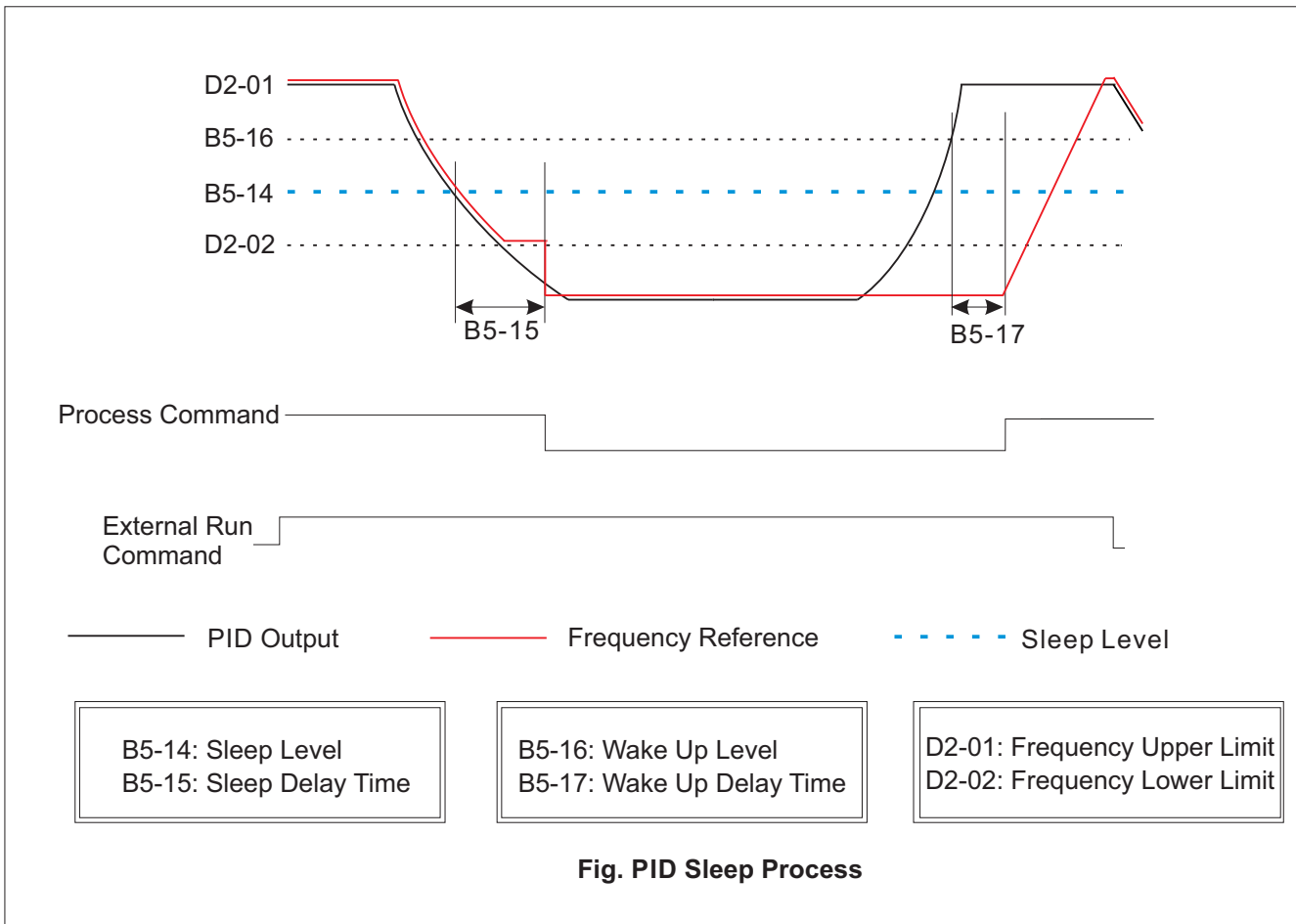

5.4.3 Motor Slip Compensation at V/F Control: C3

C3-01 Motor Rated Slip Compensation X O O O X

Setting Value
0.0~200.0 (%) @ 0.0

Function Description

This Function controls the Output Frequency in response to the Load's Torque demand, it is used for some Application needs to increase the Speed Precision in V/F Control.

The Motor Rated Slip(Hz) is as Formula:

$$= \text{Motor Rated FRQ} - \frac{\text{Motor Rated SPD} \times \text{Motor Poles}}{120}$$

- Motor Rated SPD: Please see the Motor Nameplate Data.

Note : The Slip Compensation Frequency is equal to Formula below:

$$\text{Slip Compensation FRQ} = \frac{\text{Output Current} - \text{Motor Noload Current}(E2-03)}{\text{Motor Rated Current}(E2-01) - (E2-03)} \times (C3-01) \times \text{Motor Rated Slip}$$

- The Default Value of E2-03 will be different depends the O2-04 (Inverter Model). Please adjust E2-03 up to Motor Condition.

5.4.4 Torque Compensation: C4

C4-01 Torque Compensation @ V/F X O O O X

Setting Value
0.0~30.0 (%) @ 10.0

Function Name

Torque Compensation Gain for V/F Pattern

Function Description

Normally, no Adjustment is necessary for Torque Compensation Gain. In V/F Control, please adjust the Torque Compensation Gain for follow Condition.

- Wiring Distance between the VFD and the Motor is long, Increase C4-01.
- Motor Size is less than VFD Rating, Increase C4-01.
- Motor generates excessive Vibration, Decrease C4-01.

Note : Increasing Torque Compensation Gain increases Motor Torque, but an Excessive increase may cause the following:

- VFD Fault Trips due to Motor Overexcitation
- Motor Overheat or Excessive Vibration.

5.4.5 Carrier Frequency: C6

C6-01 Carrier Frequency Set X O O X X

Setting Value
1~15 kHz @ 5

Function Name

Carrier (Switching) Frequency Selection

Function Description

With the Possibility of Running at Higher Switching Frequency that can Reduce the Audio Noise Level of Motor.

At Switching Frequency > than 5kHz, Heavy Load or Harsh Application might cause the VFD in "OH" Fault, Derating might be Needed.

C6-06 Carrier Frequency Selection X O O X X

Setting Value
Carrier Mode 0 [0]
Carrier Mode 1 @ [1]
Carrier Mode 2 [2]

Function Name

Carrier (Switching) Frequency Modulation Selection

Function Description

- [0]: Full Range SVPWM Modulation for High Speed Accuracy, Low Motor Audio Noise or High RPM Application. This setting will cause High Drive Temperature Rise, derating or additional Cooling Device if Require.
- [1]: 0~half Rated Frequency is 2 Phase Modulation for General HVAC or an Application which Speed Accuracy and Motor Noise is not so strict.
- [2]: Auto Adjusting Modulation(Random PWM) between Temperature Rise and Motor Noise.

5.5 Reference, Group (D)

5.5.1 Preset References: D1

D1-09 JOG Frequency Reference O O O X X

Setting Value
0.00~650.00 (Hz) @ 2.00
Function Description

The Jog Frequency Reference can be set in this Parameter. The VFD will Run at this Frequency when any Multifunction Digital Input Selections (H1-01~ H1-06) are set to "12 FWD JOG" or "13 REV JOG" and the selected Terminal is activated.

D1-10 JOG Acceleration Time O O O X X

Setting Value
0.1~25.5 (Sec.) @ 0.5
Function Description
Please Refer to Parameter C1-01.

D1-11 JOG Deceleration Time O O O X X

Setting Value
0.1~25.5 (Sec.) @ 0.5
Function Description
Please Refer to Parameter C1-02.

D1-12 Multi-step Speed ACC/DEC O O O X X

Setting Value
ACC/ DEC Time by C1-01~ C1-04 @ [0]
ACC/ DEC Time is up to D1-29~ D1-60 [1]
Separately
Function Name
Multi-Step Speed ACC/ DEC Time Method Selection
Function Description
[0]: The separate ACC/ Dec/ Time (D1-29 to D1-60) of Master/ Auxiliary Reference & Multi-step Speed are disabled, the ACC/ DEC Time is according to C1-01 to C1-04.
[1]: The ACC/ Dec/ Time of Master/ Auxiliary Reference (Preset Speed 0) & Multi-step Speed 1~15 (D1-14 to D1-28) are according to D1-29 to D1-60.

D1-13 MOPs Speed/ Preset Speed 0 O O O X X

Setting Value
0.00~650.00 (Hz) @ 5.00
Function Description
MOPs Speed: LCP/ Terminal MOPs Frequency Reference, if B1-01/ B1-10= "0" or "6".

D1-14 Multi-Step Preset Speed 1 O O O X X

Setting Value
0.00~650.00 (Hz) @ 5.00

D1-15 Multi-Step Preset Speed 2 O O O X X

Setting Value
0.00~650.00 (Hz) @ 10.00

D1-16 Multi-Step Preset Speed 3 O O O X X

Setting Value
0.00~650.00 (Hz) @ 15.00

D1-17 Multi-Step Preset Speed 4 O O O X X

Setting Value
0.00~650.00 (Hz) @ 20.00

D1-18 Multi-Step Preset Speed 5 O O O X X

Setting Value
0.00~650.00 (Hz) @ 25.00

D1-19 Multi-Step Preset Speed 6 O O O X X

Setting Value
0.00~650.00 (Hz) @ 30.00

D1-20 Multi-Step Preset Speed 7 O O O X X

Setting Value
0.00~650.00 (Hz) @ 35.00

D1-21 Multi-Step Preset Speed 8 O O O X X

Setting Value
0.00~650.00 (Hz) @ 40.00

D1-22 Multi-Step Preset Speed 9 O O O X X

Setting Value
0.00~650.00 (Hz) @ 45.00

D1-23 Multi-Step Preset Speed 10 O O O X X

Setting Value
0.00~650.00 (Hz) @ 50.00

D1-24 Multi-Step Preset Speed 11 O O O X X

Setting Value
0.00~650.00 (Hz) @ 0.00

D1-25 Multi-Step Preset Speed 12 O O O X X

Setting Value
0.00~650.00 (Hz) @ 0.00

D1-26 Multi-Step Preset Speed 13 O O O X X

Setting Value
0.00~650.00 (Hz) @ 0.00

D1-27 Multi-Step Preset Speed 14 O O O X X

Setting Value
0.00~650.00 (Hz) @ 0.00

D1-28 Multi-Step Preset Speed 15 O O O X X

Setting Value
0.00~650.00 (Hz) @ 0.00

D1-29 ACC of REF Source/ Preset 0 O O O X X

Setting Value
0.1~3600.0 (Sec.) @ 10.0
Function Name
ACC Time of Reference Source Speed/ Preset Speed 0

D1-30 DEC of REF Source/ Preset 0 O O O X X

Setting Value
0.1~3600.0 (Sec.) @ 10.0
Function Name
DEC Time of Reference Source Speed/ Preset Speed 0

D1-31 ACC Time of Preset Speed 1	O	O	O	X	X
Setting Value					
0.1~3600.0 (Sec.)					@ 10.0
D1-32 DEC Time of Preset Speed 1	O	O	O	X	X
Setting Value					
0.1~3600.0 (Sec.)					@ 10.0
D1-33 ACC Time of Preset Speed 2	O	O	O	X	X
Setting Value					
0.1~3600.0 (Sec.)					@ 10.0
D1-34 DEC Time of Preset Speed 2	O	O	O	X	X
Setting Value					
0.1~3600.0 (Sec.)					@ 10.0
D1-35 ACC Time of Preset Speed 3	O	O	O	X	X
Setting Value					
0.1~3600.0 (Sec.)					@ 10.0
D1-36 DEC Time of Preset Speed 3	O	O	O	X	X
Setting Value					
0.1~3600.0 (Sec.)					@ 10.0
D1-37 ACC Time of Preset Speed 4	O	O	O	X	X
Setting Value					
0.1~3600.0 (Sec.)					@ 10.0
D1-38 DEC Time of Preset Speed 4	O	O	O	X	X
Setting Value					
0.1~3600.0 (Sec.)					@ 10.0
D1-39 ACC Time of Preset Speed 5	O	O	O	X	X
Setting Value					
0.1~3600.0 (Sec.)					@ 10.0
D1-40 DEC Time of Preset Speed 5	O	O	O	X	X
Setting Value					
0.1~3600.0 (Sec.)					@ 10.0
D1-41 ACC Time of Preset Speed 6	O	O	O	X	X
Setting Value					
0.1~3600.0 (Sec.)					@ 10.0
D1-42 DEC Time of Preset Speed 6	O	O	O	X	X
Setting Value					
0.1~3600.0 (Sec.)					@ 10.0
D1-42 ACC Time of Preset Speed 7	O	O	O	X	X
Setting Value					
0.1~3600.0 (Sec.)					@ 10.0
D1-44 DEC Time of Preset Speed 7	O	O	O	X	X
Setting Value					
0.1~3600.0 (Sec.)					@ 10.0
D1-45 ACC Time of Preset Speed 8	O	O	O	X	X
Setting Value					
0.1~3600.0 (Sec.)					@ 10.0
D1-46 DEC Time of Preset Speed 8	O	O	O	X	X
Setting Value					
0.1~3600.0 (Sec.)					@ 10.0

	Run	Mod	Initial	V/F	o2-4
D1-47 ACC Time of Preset Speed 9	O	O	O	X	X
Setting Value					
0.1~3600.0 (Sec.)					@ 10.0
D1-48 DEC Time of Preset Speed 9	O	O	O	X	X
Setting Value					
0.1~3600.0 (Sec.)					@ 10.0
D1-49 ACC Time of Preset Speed 10	O	O	O	X	X
Setting Value					
0.1~3600.0 (Sec.)					@ 10.0
D1-50 DEC Time of Preset Speed 10	O	O	O	X	X
Setting Value					
0.1~3600.0 (Sec.)					@ 10.0
D1-51 ACC Time of Preset Speed 11	O	O	O	X	X
Setting Value					
0.1~3600.0 (Sec.)					@ 10.0
D1-52 DEC Time of Preset Speed 11	O	O	O	X	X
Setting Value					
0.1~3600.0 (Sec.)					@ 10.0
D1-53 ACC Time of Preset Speed 12	O	O	O	X	X
Setting Value					
0.1~3600.0 (Sec.)					@ 10.0
D1-54 DEC Time of Preset Speed 12	O	O	O	X	X
Setting Value					
0.1~3600.0 (Sec.)					@ 10.0
D1-55 ACC Time of Preset Speed 13	O	O	O	X	X
Setting Value					
0.1~3600.0 (Sec.)					@ 10.0
D1-56 DEC Time of Preset Speed 13	O	O	O	X	X
Setting Value					
0.1~3600.0 (Sec.)					@ 10.0
D1-57 ACC Time of Preset Speed 14	O	O	O	X	X
Setting Value					
0.1~3600.0 (Sec.)					@ 10.0
D1-58 DEC Time of Preset Speed 14	O	O	O	X	X
Setting Value					
0.1~3600.0 (Sec.)					@ 10.0
D1-59 ACC Time of Preset Speed 15	O	O	O	X	X
Setting Value					
0.1~3600.0 (Sec.)					@ 10.0
D1-60 DEC Time of Preset Speed 15	O	O	O	X	X
Setting Value					
0.1~3600.0 (Sec.)					@ 10.0

■ Real Acceleration/ Deceleration Time Calculation

The Acceleration Time is defined as the Time it takes for VFD Output Frequency to accelerate from 0% to 100% Motor Rated Frequency. It takes the Motor Rated Frequency (T1-05) as the Denominator in Calculation below.

$$\text{Actual ACC Time} = \frac{C1-01 \times \text{Frequency Reference}}{K} + \frac{C2-01 + C2-02}{2}$$

$$\text{Actual DEC Time} = \frac{C1-02 \times \text{Frequency Reference}}{K} + \frac{C2-03 + C2-04}{2}$$

Note: K= E1-06 if A1-02=0 (V/F Control) or K= T1-05 if A1-02=5 (VVT Control)

i.e.: A1-02=0, E1-06= 50Hz(Maximum Output Frequency), D1-14=10Hz(Preset Speed), D1-31= 5Sec.(ACC Time), D1-32= 20Sec. (DEC Time), C2-01~C2-04= 0.2Sec.(S-Curve)

$$\text{ACC Time} = \frac{D1-31 \times 10\text{Hz}}{E1-06} + \frac{0.2 + 0.2}{2} = 1.2 \text{ (S)}$$

$$\text{DEC Time} = \frac{D1-32 \times 10\text{Hz}}{E1-06} + \frac{0.2 + 0.2}{2} = 4.2 \text{ (S)}$$

■ When D1-12=1 (ACC/ DEC Time is up to D1-29~ D1-60), there are two Time Setting modes as example below.

i.e. B1-02=1 (Terminals), B1-11=1 (RUN/STOP & FWD/REV), H1-01=80 (D1= FWD/STOP), H1-02= 81 (D2= REV/STOP), H1-03=3 (D3= Preset Speed bit 1), H1-04=4 (D4= Preset Speed bit 2), H1-05= 5 (D5= Preset Speed bit 3).

● Mode 1: ACC/ DEC Time Calculation for each Preset Speed, when RUN Command off & On.

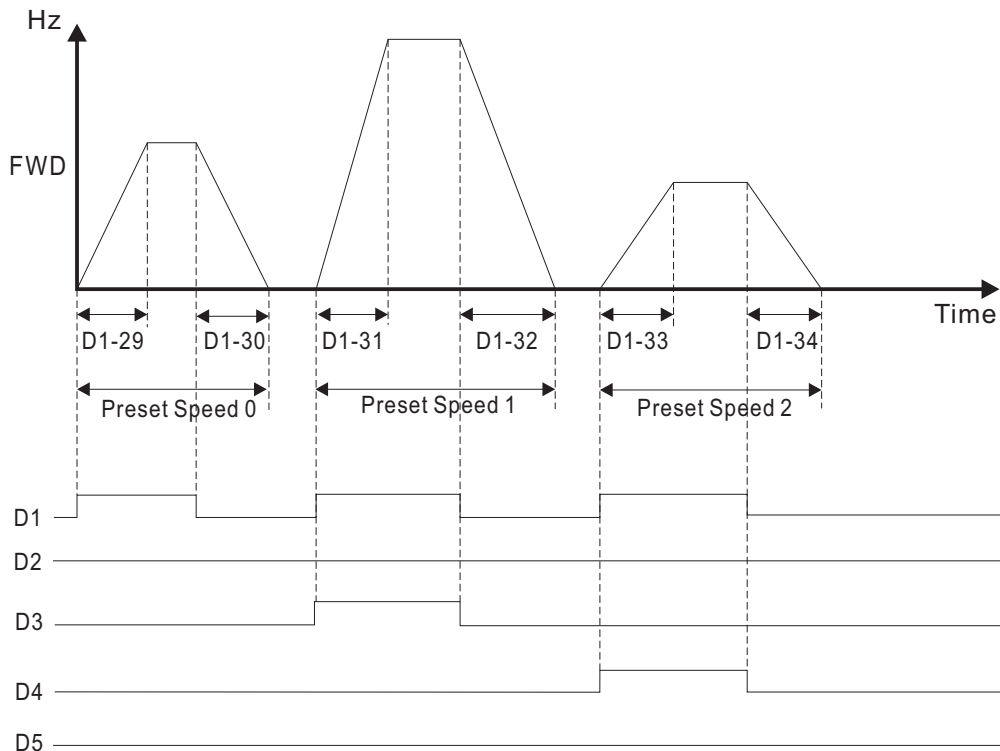

Fig. 1-1

●Mode 2: ACC/ DEC Time Calculation for each Preset Speed, when RUN Command Continued.

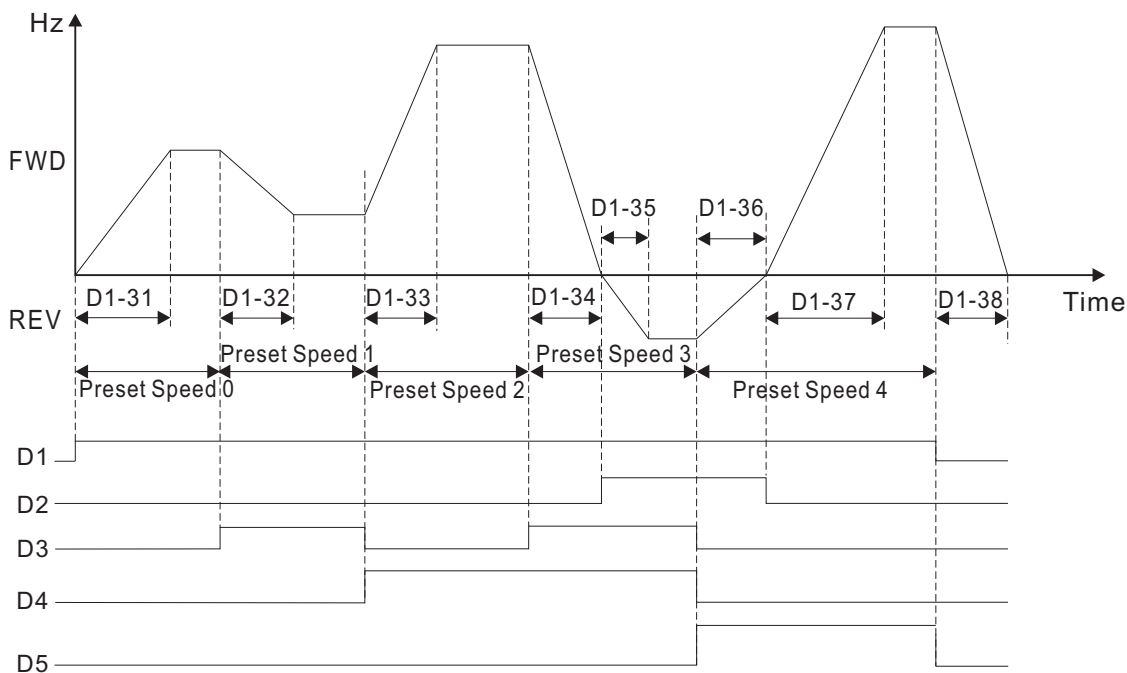

Fig. 1-2

Note:

The D1-31 to D1-38 shown in the Figure are the Time Base for ACC/ DEC., the Real ACC/DEC Time, will be different in according with different Reference.

5.5.2 References Limits: D2

D2-01 Frequency Upper Limit	X O O X X
Setting Value	
0.1~100.0 (%)	@ 100.0
Function Name	
Frequency Reference Upper Limit	
Function Description	
Set the Output Frequency Upper Limit as a Percentage of the Maximum Frequency (E1-04)	

D2-02 Frequency Lower Limit	X O O X X
Setting Value	
0.0~99.0 (%)	@ 0.0
Function Name	
Frequency Reference Lower Limit	
Function Description	
Set the Output Frequency Lower Limit as a Percentage of the Maximum Frequency (E1-04)	

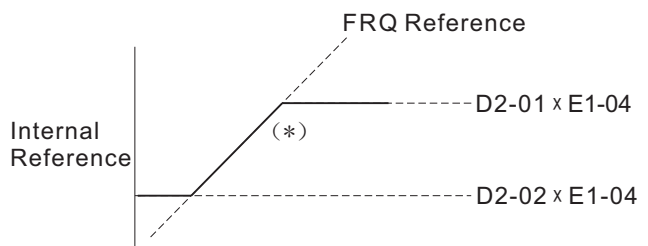

- *: 1. If D2-02= 0% and Frequency Reference= 0, then VFD is in 0 Speed.
- 2. If D2-02> 0% and FRQ Reference≤ D2-02 × E1-04, then VFD Output by D2-02 × E1-04 Value.

5.5.3 Jump Frequencies: D3

This Function allows the Prohibition or “Jumping” of Critical Frequencies so that the Motor can operate without Resonant Vibrations caused by some Machine Systems. This Function is also used for Dead-Band Control. Setting the Value to 0.00Hz disables this Function.

D3-01 Jump Frequency Reference 1 X O O X X

Setting Value

0.00~650.00 (Hz) @ 0.00

Function Name

Set the Center Value of Prohibition Frequency

D3-02 Jump Frequency Reference 2 X O O X X

Setting Value

0.00~650.00 (Hz) @ 0.00

D3-03 Jump Frequency Reference 2 X O O X X

Setting Value

0.00~650.00 (Hz) @ 0.00

D3-04 Jump Frequency Bandwidth X O O X X

Setting Value

0.00~30.00 (Hz) @ 0.00

Function Name

The Prohibition Frequency Range is equal to $D3-0_{\pm} D3-04$
(Jump Frequency Reference \pm Bandwidth)

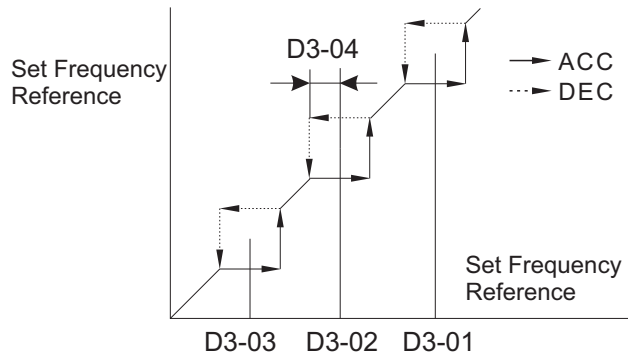

5.6 V/F Pattern & Motor, Group (E)

5.6.1 V/F Pattern: E1

E1-01 Input Mains Voltage X O O O X

Setting Value

170.0~264.0 (VAC) @ 220.0
323.0~528.0 (VAC) @ 380.0

Function Description

Sets the VFD Input Voltage in Units of 1V, this Value as Datum of Protection Function. Please Set the Value in according to Actual Mains Voltage.

E1-03 V/F Pattern Selection X O O O X

Setting Value

Preset V/F Pattern can be Selected [0]~[E]
Custom V/F Pattern can be Set @ [F]

Function Description

Choose a Preset V/F Pattern for Operation in V/F Modes only. It may be necessary to change the V/F Pattern when using a High-Speed Motor, or when Special Torque Adjustment is required in the Application. Set the V/F Pattern according to the Applications described in the Table **V/F Pattern for Applications**.

■ V/F Pattern for Applications

Application	Specification	E1-03 Value	
General Purpose	50Hz	0,F*	
	60Hz	1,F*	
	60Hz (50Hz Saturation)	2	
	72Hz (60Hz Saturation)	3	
Variable Torque	50Hz	Variable Torque 1	4
		Variable Torque 2	5
	60Hz	Variable Torque 1	6
		Variable Torque 2	7
High Starting Torque	50Hz	High Starting Torque 1	8
		High Starting Torque 2	9
	60Hz	High Starting Torque 1	A
		High Starting Torque 2	B
High Speed Operation	90Hz (60Hz Saturation)	C	
	120Hz (60Hz Saturation)	D	
	180Hz (60Hz Saturation)	E	

Note:

- The Default V/F Specification (Setting: F) depends on A1-03 Initialize Value.
 - For 50Hz, the factory setting is accorded to **Value 0**.
 - For 60Hz, the factory setting is accorded to **Value 1**
- Accords to different Power Rating, the Related Frequency and Voltage of Pattern should be different, please refer to Page 5-19 & 20 for actual Value.

Note:

- The Following Conditions must be considered when selecting a V/F Pattern:
 - The Voltage and Frequency Characteristics of the Motor.
 - The Maximum Speed of the Motor.
- Select a High Starting Torque V/F Pattern Only under the Following Conditions:
 - The Wiring Distance is long.
 - Large Voltage Drop at Start-up.
 - AC Reactor is connected to the VFD's Input or Output.

■ 1.5kW & less V/F Pattern

The Voltages shown below are for 200 V class VFDs. Double the Voltages if 400 V class VFDs.

● General Purpose (Value: 0~3)

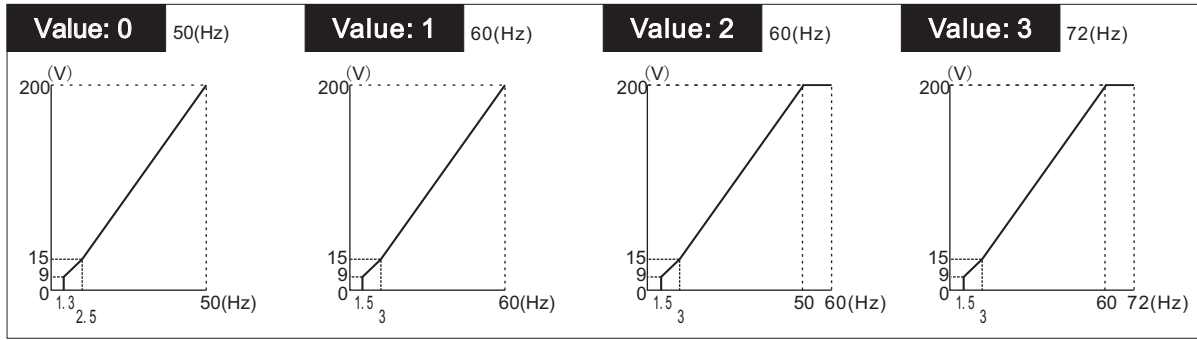

● Variable Torque (Value: 4~7)

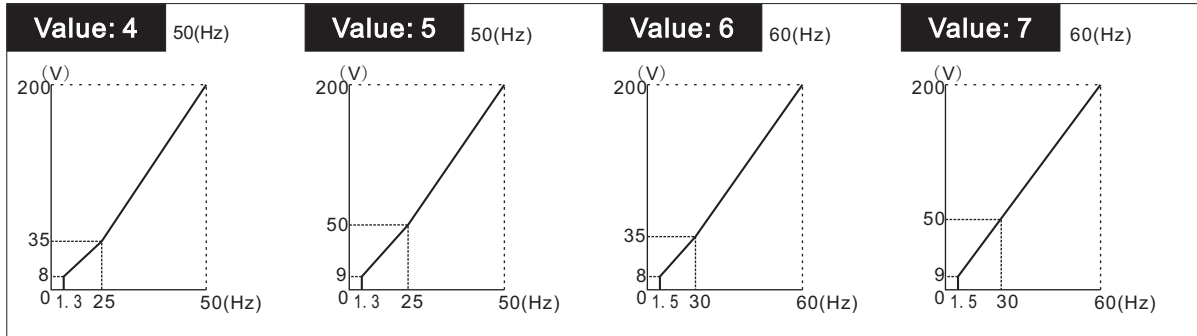

● High Starting Torque (Value: 8~B)

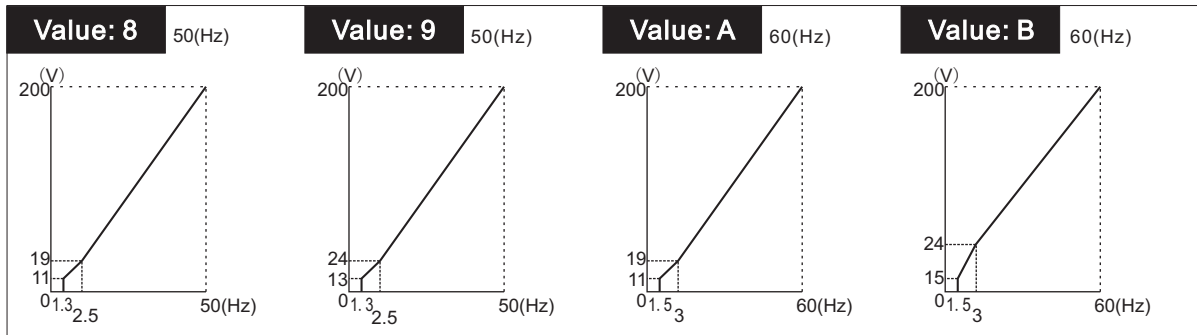

● High Speed Operation (Value: C~E)

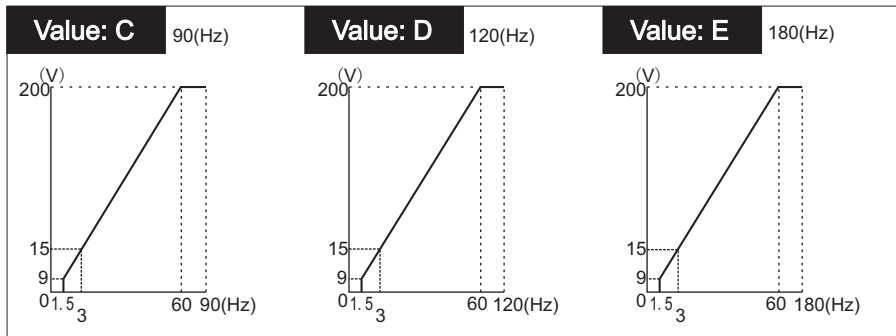

■ 2.2~ 22kW V/F Pattern

The Voltages showed below are for 200 V class VFDs. Double the Voltages if 400 V class VFDs.

● General Purpose (Value: 0~3)

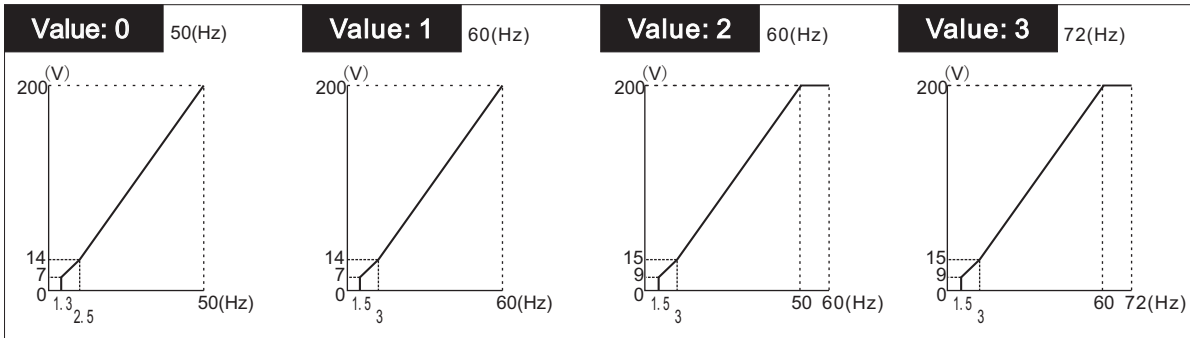

● Variable Torque (Value: 4~7)

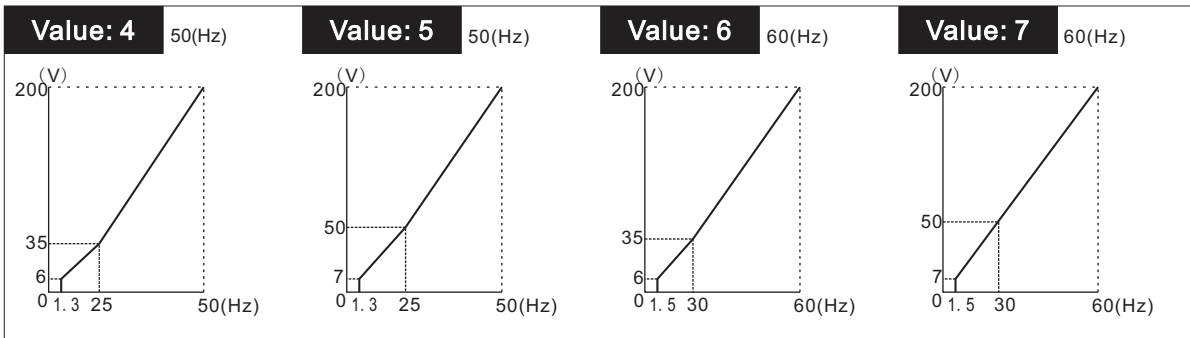

● High Starting Torque (Value: 8~B)

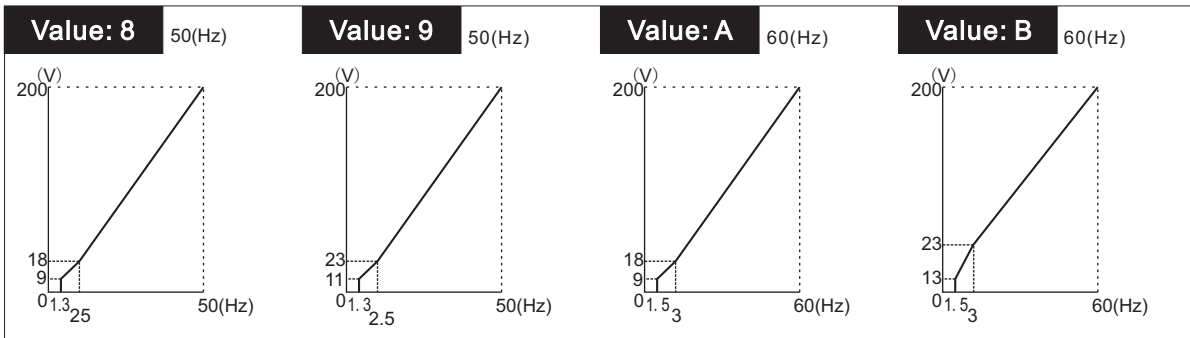

● High Speed Operation (Value: C~E)

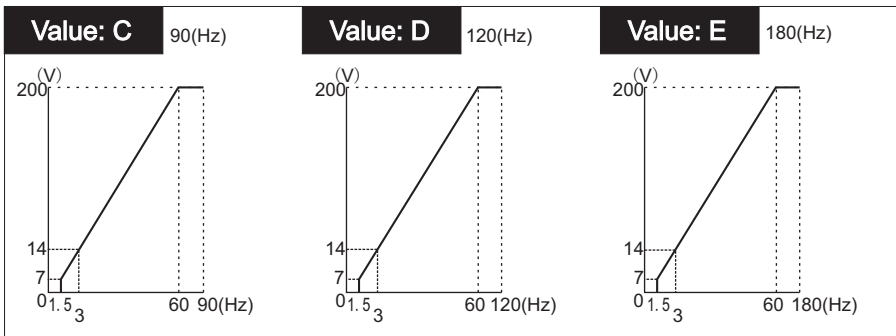

■ Custom V/F Pattern

Set up a Custom V/f Pattern by setting Parameter E1-03 to "F", and then setting the Values in Parameters E1-04 to E1-13

E1-04 Maximum Output Frequency	X	O	O	X	X
Setting Value					
40.00~650.00 (Hz)					@ 50.00

E1-05 Maximum Output Voltage	X	O	O	O	X
Setting Value					
0.0~255.0 (V)					@ 200.0

E1-06 Base Frequency	X	O	O	O	X
Setting Value					
0.10~650.00 (Hz)					@ 50.00

E1-07 Middle Output Frequency A	X	O	O	O	X
Setting Value					
0.10~650.00 (Hz)					@ 2.50

E1-08 Middle Output Voltage A	X	O	O	O	X
Setting Value					
0.0~255.0 (V)					@ 15.0

E1-09 Minimum Output Frequency	X	O	O	O	X
Setting Value					
0.10~650.00 (Hz)					@ 1.30

E1-10 Minimum Output Voltage	X	O	O	O	X
Setting Value					
0.0~255.0 (V)					@ 9.0

E1-11 Middle Output Frequency B	X	O	O	O	X
Setting Value					
0.00~650.00 (Hz)					@ 0.00
Function Description					
This Function is disabled if Value= 0.00Hz					

E1-12 Middle Output Voltage B	X	O	O	O	X
Setting Value					
0.0~255.0 (V)					@ 0.0
Function Description					
This Function is disabled if Value= 0.0V					

E1-13 Base Voltage	X	O	O	O	X
Setting Value					
0.0~255.0 (V)					@ 200.0
Function Description					
This Function is used to do fine Tuning for High Speed Operation Area. No need in General.					

Be sure to satisfy the following Conditions for Setting Parameters E1-04 to E1-13

- $E1-09 \leq E1-07 < E1-06 \leq E1-11 \leq E1-04$
- Parameters E1-04 through E1-10 can be set by the User when E1-03 has been set to "F". These Parameters are not valid for read and write when E1-03 isn't set to "F".
- When making the V/F Patterns a Straight Line, set the same Value in E1-07 (Middle Output Frequency A) and E1-09 (Minimum Output Frequency). In this case, Parameter E1-08 (Middle Output Frequency Voltage A) will be Disregarded.
- These Voltage Values are for the 200 V Class; Double the Values for 400 V Class VFDs.

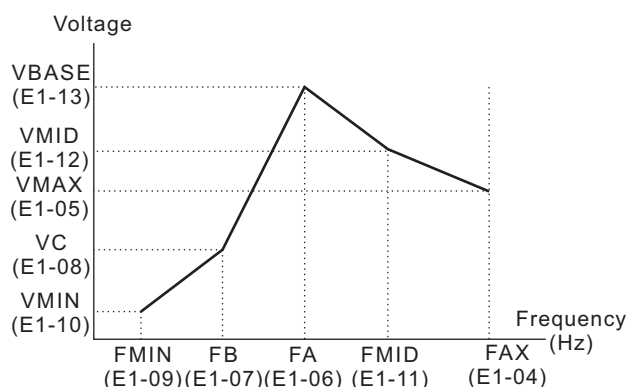
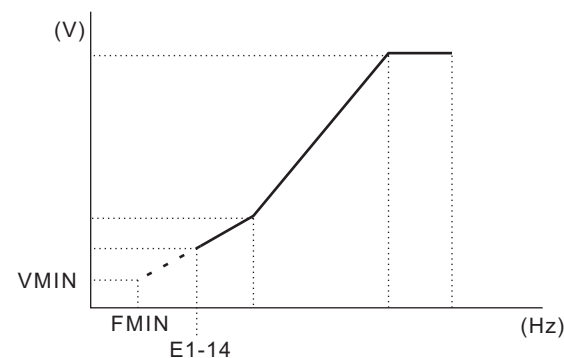

Fig. Custom V/F Pattern

E1-14 V/F Start Frequency	X	O	O	O	X
Setting Value					
0.00~10.00 (Hz)					@ 0.00
Function Description					

The VFD will start to Output Frequency from this set Level accords to V/F Pattern set then Acc/Dec to Internal Reference. For V/F Control Only.



Note: When VVT Control (A1-02=5), the VFD will output the Frequency in accordance with V/F Pattern built-in. Only Parameter E1-04 is valid for setting, but the following Conditions $E1-09 \leq E1-07 < E1-06 \leq E1-11 \leq E1-04$ is still need to satisfy for Setting Parameters E1-04 to E1-13.

5.6.2 Motor Set-up: E2 (V/F Control Only)

E2-01 Motor Rated Current X O O O O

Setting Value

The Default & Setting Varies depending on the VFD Model (o2-04) & Motor Rating. @

Function Description

Sets the Rated Current in units of A for Motor Nameplate Data.

E2-04 Number of Motor Poles X O O O X

Setting Value

2~48 (2Poles) @ 4

Function Name

Sets the Number of Motor Poles as Nameplate Rcorded.

E2-03 Motor No-Load Current X O O O X

Setting Value

The Default & Setting Varies depending on the VFD Model (o2-04) & Motor Rating. @

Function Description

This Value as datum of Motor Slip Compensation. Sets the Value as the Current of Motor running at Rated Frequency , Rated Voltage. Please Contact Motor Manufacture if no Data recorded on Motor Nameplate.

5.6.3 Operating Direction Definition: E6

E6-01 Motor Direction Selection O O O X X

Setting Value

Direct Rotation @ [0]

Inverse Rotation [1]

Function Name

Motor Rotating Direction Definition

5.7 外部端子 (H)的参数

5.7.1 D多功能输入: H1

TYD101有六 多功能接 入端 置 多的功能，包括多步速度操作，PID，速度搜索，和其他功能。

H1-01 端子D1功能选择 X O O X X

取值

3~89 @ [80]

功能

多功能输入1：端子D1的功能选择

功能说明

参考以下说明。

H1-02 端子D2功能选择 X O O X X

取值

3~89 @ [81]

功能

多功能输入2：端子D2的功能选择

功能说明

参考以下说明。

H1-03 端子 D3 功能选择 X O O X X

取值

3~89 @ [3]

功能

多功能输入3：端子D3的功能选择

功能说明

参考以下说明。

H1-04 端子 D4 功能选择 X O O X X

取值

3~89 @ [4]

功能

多功能输入4：端子D4的功能选择

功能说明

参考以下说明。

X O O X X

取值

3~89 @ [5]

功能

多功能输入5：端子D5的功能选择

功能说明

参考以下说明。

H1-06 端子D6 功能选择 X O O X X

取值

3~89 @ [30]

功能

多功能输入6：端子D6的功能选择

功能说明

参考以下说明。

下表列出了多功能接触输入功能选择（端子D1至D6）。

●多功能触点输入功能表

取值	功能说明
3	多步参考位0.
4	多步参考位 1
5	多步参考位 2
A	保持加减速停止 (On: 停止加减速.保持频率)
10	UP指令(请务必与DOWN同时设定)
11	DOWN指令 (请务必与UP同时设定)
12	点动正转运行
13	点动反转运行
14	故障复位(ON的上升沿时复位)
15	快速停止(E.S.)
19	PID 控制取消
1A	加减速时间选择2
30	PID 控制积分复位t (On: 积分复位)
32	多步参考位3
80	正转运行
81	反转运行
82	遮断停止（自由运转停止）
83	主/辅运转信号切换
84	主/辅频率切换
85	KEB穿越功率恢复
86	自动程序运转
87	j计数器触发器信号输入
88	清除计数器
89	脉冲输入（D6）

注：请参阅参数a1-03，b1-02，b1-11，查看2线/3线制端子的更多信息。

● 多段速端子0~3 (设置: 3,4,5,32)

多段速参考点0到3 (设定值= 3, 4, 5, 32), 见表多段速的参考

多段速参考

	多段速端子			
	bit 3	bit 2	bit 1	bit 0
主/辅助参考源, 预置速度 0	0	0	0	0
D1-14 多段速 1	0	0	0	1
D1-15 多段速 2	0	0	1	0
D1-16 多段速 3	0	0	1	1
D1-17 多段速 4	0	1	0	0
D1-18 多段速 5	0	1	0	1
D1-19 多段速 6	0	1	1	0
D1-20 多段速 7	0	1	1	1
D1-21 多段速 8	1	0	0	0
D1-22 多段速 9	1	0	0	1
D1-23 多段速 10	1	0	1	0
D1-24 多段速 11	1	0	1	1
D1-25 多段速 12	1	1	0	0
D1-26 多段速 13	1	1	0	1
D1-27 多段速 14	1	1	1	0
D1-28 多段速 15	1	1	1	1

[1]: 位被激活

[0]: 位被停用

注: 当B1-01 / B1-10设置为“0” (LCP MOPs) 或“6” (终端MOPs) 并且参考是通过选择的方式, d1-13是有效的。预设速度0应为d1-13 (LCP MOPs或终端MOPs)。

◆ 例 由变频器内的参数设定的频率进行3段速运行

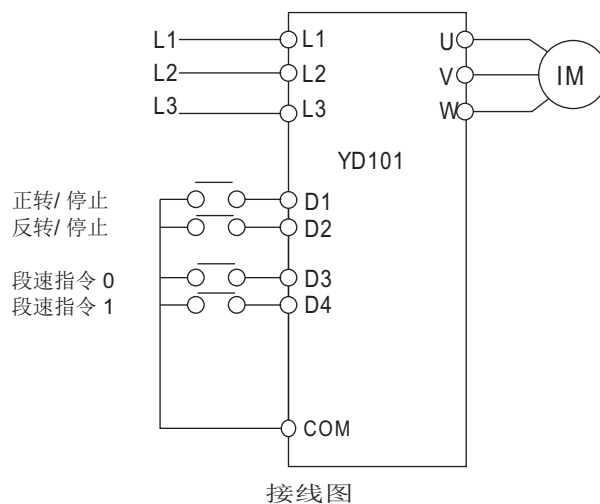
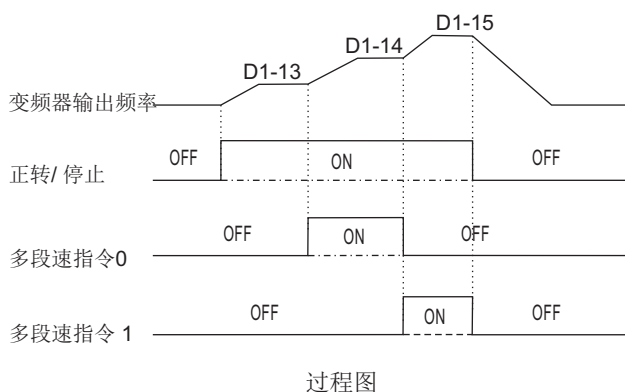

表格 参数设定

参数编号.	名称	设定值
B1-01	参考源选择	0, LCP MOPs
B1-02	命令源选择	1, 终端
D1-13	MOPs 速度/ 预置速度 0	xx.xx Hz
D1-14	多段速预置速度 1	xx.xx Hz
D1-15	多段速预置速度 2	xx.xx Hz
H1-01	终端输入选择 D1	80, 正转操作
H1-03	终端输入选择 D3	3, 多段速参考位 0
H1-04	终端输入选择 D4	4, 多段速参考位 1

● 加减速时间斜坡保持 (设置: A)

当保持命令输入时，加/减速的命令是用来暂时在目前的基准频率保持输出频率。
当输入停止指令、加/减速的保持条件释放并停止操作。

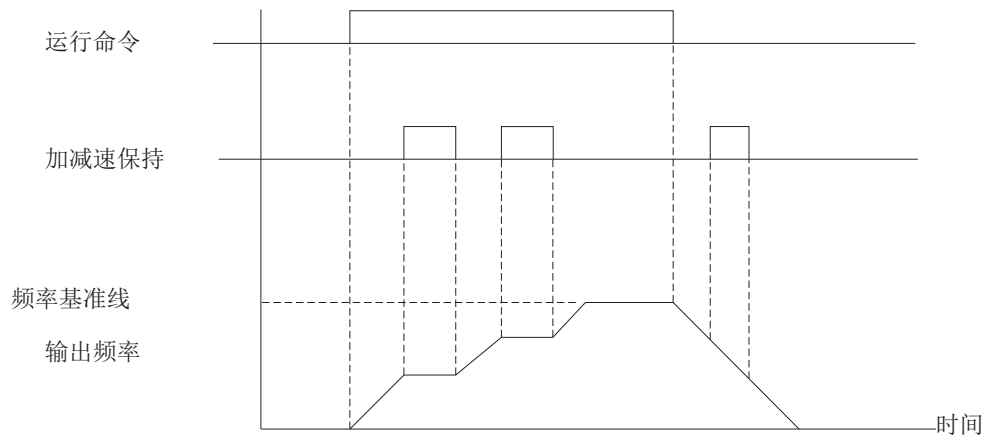

● MOPs命令 (设置: 增加=“10”。下降, 减少=“11”)

- 1、使用这一功能时，一定要把b1-01 = 6 (由终端MOPs作为参考)，LCP的MOP功能被禁用。
- 2、当使用此功能时，一定要设置UP命令 (设置10) 和DOWN命令 (设置11)。
- 3、MOP频率上/下命令操作是根据C1 - 01到C1-04的正常加速/减速时间。
- 4、频率的限制，输出频率与拖把的命令是由d2-01确定 (上限) 和d2-02 (下限) 的设置。
- 5、请阅读h1-13 h1-14参数，获得更多的信息。

MOP Up (增加)	激活	抑制	抑制	激活
MOP Down (减少)	抑制	激活	抑制	激活
操作 (状态)	加速	减速	保持	保持

● FWD JOG/ REV JOG Operation (setting: FWD= “12”. REV= “13”)

1. The VFD is running on Jog Frequency (D1-09) and Rotating in which Direction when the FWD or REV JOG Command is Input. Uses the D1-10/ D1-11 (JOG ACC/ DEC Time) to set the Accel or Decel Time.
2. The Priority of Frequency Reference is Jog> Preset Speed> Else.

● Fault Reset (setting: 14)

- ◆ Please Identify and Correct the Cause of Fault First when a Fault Occurred, then could reset the Fault. If Reset the Fault often without Correct the Cause of Fault, it may make the VFD Damaged.
- ◆ To Restart the VFD, Remove any Run Command and Turn ON the Reset Input Signal or depress the RESET Key on the LCP, or cycle Power to Reset the Stop Status if precious Actions doesn't work. If taking the Remedial Actions described does not solve the problem, it should be some part of VFD is fail.
- ◆ When VFD is during Operation under no Fault, No matter for VFD if On-Off the Reset Signal.

● Fast Stop (Emergency Stop) (setting: 15)

When this Function is activated (ON), the VFD Decelerates to Stop using Deceleration Time C1-04 (Factory Set to 10 Sec.). The Display shows E.S. in Blinking. The Stop Method of Fast Stop is not Limited by B1-03 Setting.

To clear the Fast Stop, Turn OFF the Run Command, Turn OFF the Fast Stop Input, and then Turn ON the Run Command again.

The Relay (PHC) will Output or not when VFD in Fast Stop, it depends the Set of H2-01/ 02/ 03. If H1-01/ 02/ 03 =1, it will Activates.

● PID Control Disable (setting: 19)

Activated (ON): PID Control is Disabled, Normal VFD Operation.

Inactivated (OFF): PID Control is Enabled by Set B5-01.

- ACC/ DEC Time 2 Selection (setting: 1A)

Activated (ON): Acceleration/ Deceleration Time is set by Parameters C1-03 and C1-04.

Inactivated (OFF): Acceleration/ Deceleration Time is set by Parameters C1-01 and C1-02.

- PID Integral is Reset (setting: 30)

Activated (ON): PID Integral Value is set to Zero.

Inactivated (OFF): PID Integral Values are Added.

- FWD/ REV Operation (setting: FWD/ STOP= "80", REV/ STOP= "81")

Activated (ON): VFD is Operating at Defined Direction.

Inactivated (OFF): VFD is Ramp/ Coast to Stop by Set B1-03 or not Functional up to VFD's Original Status.

- External Baseblock (B.B.) (setting: 82)

When an External Baseblock Signal is Input while the VFD is Running, "b.b." Blinks on the LCP's Display, and the VFD Output is Shut OFF (Not Limited by B1-03). When the External Baseblock Signal is Removed, Operation Restarts again by Speed Search.

- Master/ Auxiliary Run Command Selection (setting: 83)

Activated (ON): Run Command Source by Set B1-09.

Inactivated (OFF): Run Command Source by Set B1-02.

- Master/ Auxiliary Frequency Reference Selection (setting: 84)

Activated (ON): Frequency Reference Source by Set B1-10.

Inactivated (OFF): Frequency Reference Source by Set B1-01.

- KEB Ridethrough Power Restore (setting: 85)

In General Applications, the Kinetic Energy Braking (KEB) Control Circuit attempts to maintain the DC Bus Voltage at Voltage Level above the Undervoltage Detection Level during Momentary Power Loss, by using Load Inertia to Regenerate Voltage back to the DC Bus. The VFD Decelerates at L5-08 (Kinetic Energy Braking Deceleration Time), until Power is Restored, or until the Time Runs Out and an Undervoltage Fault (UV) occurs.

The Larger the Inertia, the Longer the Deceleration Rate can be Extended. If the Inertia is Small, then the VFD must Decelerate Quickly to Regenerate Voltage back to the DC Bus, and thus the Ridethrough Time is Shorter. For Most Applications, set L5-08 to "0.0" (Factory Default).

- Auto Process Operation (setting: 86)

Coordinates with Parameter Group P, Activates this Function to Run the Auto Process.

Please Refer to Parameter Group P.

- Counter Trigger Signal (setting: 87)

Refer to Parameters H1-19 and H1-20

- Counter Reset (setting: 88)

When this Function is activated (ON), the Internal Counter's Present Value (U1-47) will be Reset (Clear to "0"). The Counter start to receive the Trigger Signal again until this Function is Inactivated.

- Pulse Input (setting: 89)

This Function is for Multi-function Input Terminal D6 only. It is used for Pulse Train or PWM Signal Input.

Refer to Parameters H1-15~ H1-18.

H1-11 D1~ D5 Input Signal Selection X O O X X

Setting Value

00000 @ 00000

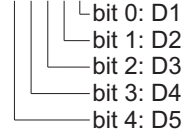

Meaning of Value in bit 0~ bit 4:

- [0]: Make Signal (N.O.)
- [1]: Break Signal (N.C.)

Function Name

N.O. or N.C. Setting of Terminal D1 to D5

Function Description

- [0]: Signal Inputs (Activated) when Closed (Make).
- [1]: Signal Inputs (Activated) when Opened (Break).

Note: Please Do Not set the Operation Command Source by Terminals before Change the Signal Selection for D1~D6. The Unintended Start could result in Death, Serious Injury, Equipment, or Property Damage.

Run Mod Initial V/F o2-4
H1-13 MOP Control Bandwidth X O O X X

Setting Value

0.00~ 5.00 @ 0.00

Function Description

There are Two Operation Mode for this Parameter as Following:

1. H1-13="0.00"
 VFD ACC to D1-13 then keep in Stable Frequency that a Run Command is On. The Output Frequency will Ramp Increase/ Decrease Frequency up to MOPs Command is Input, the Frequency is in Stable if MOPs removed. Please see Fig. H1-13=0.00.
2. H1-13≠"0.00"
 VFD ACC to D1-13 then keep in Stable Frequency that a Run Command is On. The Output Frequency will Increase/ Decrease to D1-13± H1-13 up to MOPs Command is Input. If the MOPs depress more longer than 2 Seconds the MOP Function should be same as when H1-13="0.00". Please see Fig. H1-13≠ 0.00.

H1-12 D6 Input Signal Selection X O O X X

Setting Value

00000 @ 00000

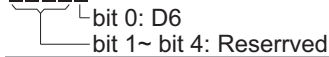

Function Description

N.O. or N.C. Setting of Terminal D6
 Refer to H1-11

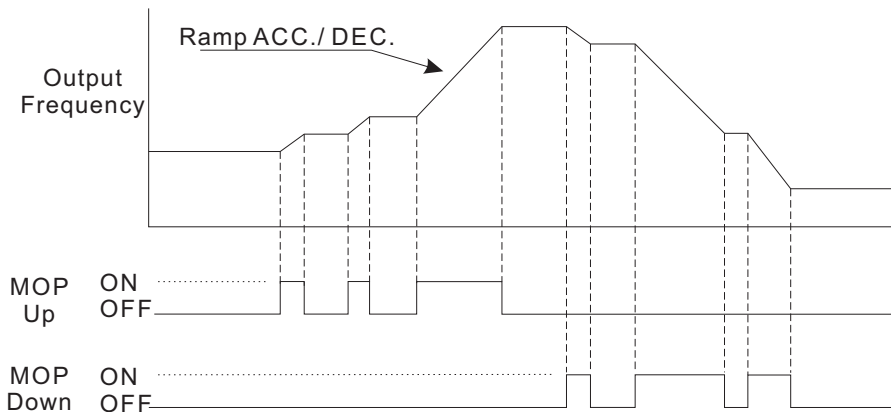

Fig. H1-13= "0.00"

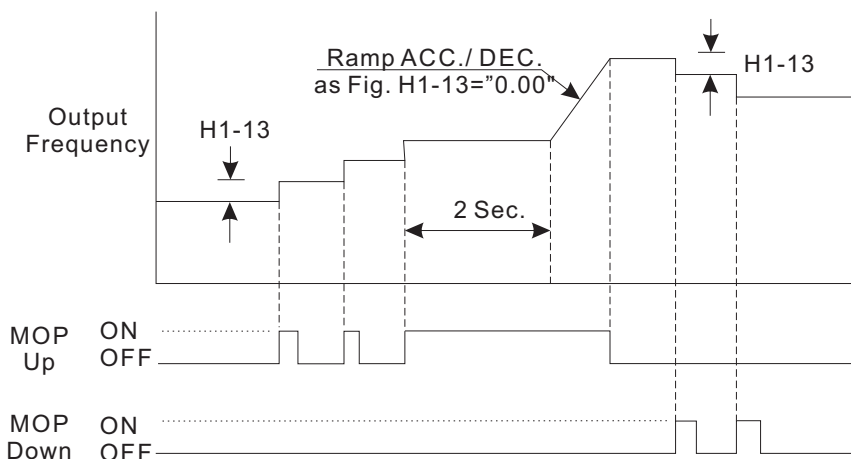

Fig. H1-13≠ "0.00"

H1-14 MOP Hold Reference Selection X O O X X**Setting Value**

Held Frequency during MOP Operation is Retained. @ [0]

Held Frequency during MOP Operation not Retained. [1]

Held Frequency during MOP Operation is Retained and MOP Increase/Decrease is still Enable while in STOP. [2]

Function Name

Hold Reference Memory Selection for MOP Control

Function Description

[0]: The VFD Stop refer to B1-03 and Frequency Reference will be stored in D1-13 once Run Command is Off. MOP Increase/Decrease is Disable while VFD in STOP.

[1]: Held Frequency during MOP Operation not Retained. If the VFD Start at 0Hz if a Run Command is ON, the VFD Stop refer to B1-03 and Output Frequency will not be stored after Run Command is Off.

[2]: The VFD Stop refer to B1-03 and Frequency Reference will be stored in D1-13 once Run Command is Off and MOP Increase/Decrease is still Enable while VFD in STOP.

H1-15 Pulse Input Signal Selection X O O X X**Setting Value**

PWM @ [0]

Pulse Train [1]

Function Description

[0]: Pulse Width Survey Mode.

[1]: Pulse Frequency Survey Mode.

H1-16 Pulse Input Filter Coefficient X O O X X**Setting Value**

0~ 100 @ 1

Function Name

Pulse Input RMS Filter Coefficient

H1-17 Pulse Input Gain X O O X X**Setting Value**

0.01~ 9.99 @ 1.00

Function Description

- Parameter Setting for Terminal D6 by Pulse Train Inputs
B1-01= 4 (Reference Source by Pulse Train/ PWM Input)

- Parameter Setting Description for Counter Function.

The Counter Trigger input can be connected to an External Pulse Generator when Counting a Process Step or Unit of Material. The Parameter below is needed for Counter Function.

1. Multi-function Terminal Input (D1~D6):

A Terminal H1-0_ = 87 (Counter Trigger), a Terminal H1-0_ = 88 (Counter Reset)
H1-19=1~9999, H1-20=1~9999.

2. Relay/ PHC Output Setting:

H2-01~03= 46 (Target Value), when Counter Current Value attains this set Value, Relay/ PHC will Activate, and Inactivates by Next Trigger.

H2-01~03= 47 (Preset Value), when Counter Current Value attains this set Value, Relay/ PHC will Activate, and Inactivates as same as Set Value= 46.

H2-01~03= 48, (Counter in Triggering Level)

Note: Each Counter Trigger Signal is activated on Rise Edge and Inactivates on Fall Edge, the Counter's Current Value will be Reset when the Multi-function Terminal Input have set to "88 Counter Reset" and activates, or the Counter Target Value Attains.

H1-06= 89 (D6-Pulse Input)

H1-15= 1 (Pulse Frequency Survey Mode)

H1-17= 0.01~ 9.99

$$\text{VFD Frequency REF} = \frac{\text{Input Pulse FEQ}}{100} \times (\text{H1-17})$$

The Maxi. VFD Frequency is \leq D2-01 (Frequency Upper Limit)

Note: The Standard Pulse Train Input Frequency is 10~5kHz, 10kHz Maximum.

- Parameter Setting for Terminal D6 by PWM Inputs
B1-01= 4 (Reference Source by Pulse Train/ PWM Input)

H1-06= 89 (D6-Pulse Input)

H1-15= 0 (Pulse Width Survey Mode)

H1-17= 0.01~ 9.99

$$\text{VFD Frequency REF} = \text{Pulse Width Duty} \times (\text{D2-01})$$

Note: PWM allowed Cycle Range: 1~100mS.

H1-18 Pulse Reference Filter for LCP X O O O X**Setting Value**

1~200 @ 20

Function Name

Pulse Input Signal Filter Coefficient for LCP Displayed

Function Description

Increase this set Value if Frequency Reference shown in LCP is Hunting when Pulse Input Function is used.

H1-19 Counter Target Value X O O O X**Setting Value**

0~9999 @ 0

H1-20 Preset Counter Value X O O O X**Setting Value**

0~9999 @ 0

H1-21 Counter Input Scan Time X O O O X**Setting Value**

1~10 (X 2mS.) @ 1

• Counter Timing Diagram

The Counter Trigger Input can be connected to an External Pulse Generator when Counting a Process Step or Unit of Material. The Time Diagram below shows how the Counter working and Setting, please read description on Next Page.

i.e. H1-19=5, H1-20=3 (H1-19 > H1-20), H2-01=47, H2-02=46

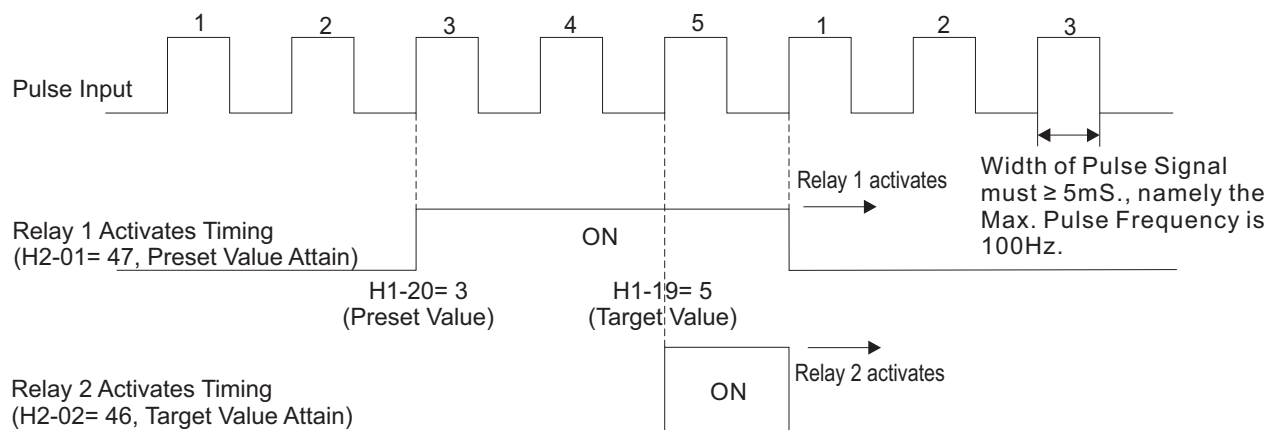

Fig. Counter Timing Diagram

Note: The Pulse Frequency Range is 0~100Hz for the Counter Input.

5.7.2 Digital Outputs: H2

H2-01 Relay 1(RY1) Function Selection X O O X X

Setting Value

0~48

@ [E]

H2-03 PHC Function Selection X O O X X

Setting Value

0~48

@ [2]

Function Name

Photo-coupler Transistor Output

H2-06 Digital Output Signal Selection X O O X X

Setting Value

00000

bit 0: RY1
bit 1: RY2
bit 2: PHC
bit 3, 4: Reserved

@ 00000

Meaning of Value in bit 0~ bit 2:

[0]: Make Signal (N.O.)

[1]: Break Signal (N.C.)

Function Name

N.O. or N.C. Setting of Terminal RY1, RY2, PHC

Function Description

[0]: Terminal Closes (Make) when Signal Outputs (Activated).

[1]: Terminal Opens (Break) when Signal Outputs (Activated).

H2-02 Relay 2(RY2) Function Selection X O O X X

Setting Value

0~48

@ [0]

• Multi-function Digital Outputs Function List

Set Value	Function Description
0	During Run
2	Frequency Agree
3	Desired Frequency Agree
4	Frequency Detection 1
5	Frequency Detection 2
E	Fault
17	Over Current Detection
1E	Restart Enabled
1F	Motor Overload (OL1) Pre-Alarm (90%)
41	Power Loss Righthrough
42	Fast Stop (E.S.)
43	In Baseblock (B.B.)
44	VFD Overload (OL2)
45	PID Feedback Lost
46	Counter Target Value Attains
47	Counter Preset Value Attains
48	Counter Signal in Triggering Level
49	Stall Prevention activates during in Run

• During Run (setting: "0")

Activates when a Run Command is Input, or when the VFD Outputs Voltage.

• Frequency Agree (setting: "2")

Activates whenever the Output Frequency "Agrees" with the Frequency Reference, Plus or Minus the Free Agree Detection Width (L4-02). This is Effective during Both Forward and Reverse Operation.

$$F_{det} = \text{Reference} \pm L4-02$$

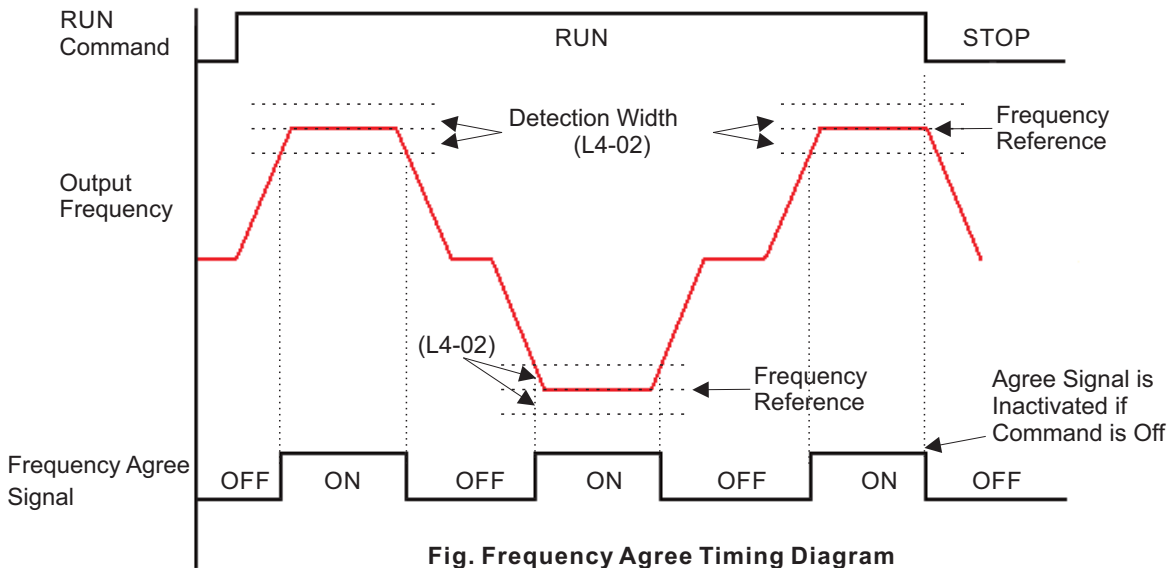

• Desired Frequency Agree (setting: "3")

Activates whenever the Output Frequency "Agrees" with the Frequency Agree Detection Level, Plus or Minus the Speed Agree Detection Width (L4-02). This is Effective during Both Forward and Reverse Operation.

$$F_{det} = L4-01 \pm L4-02$$

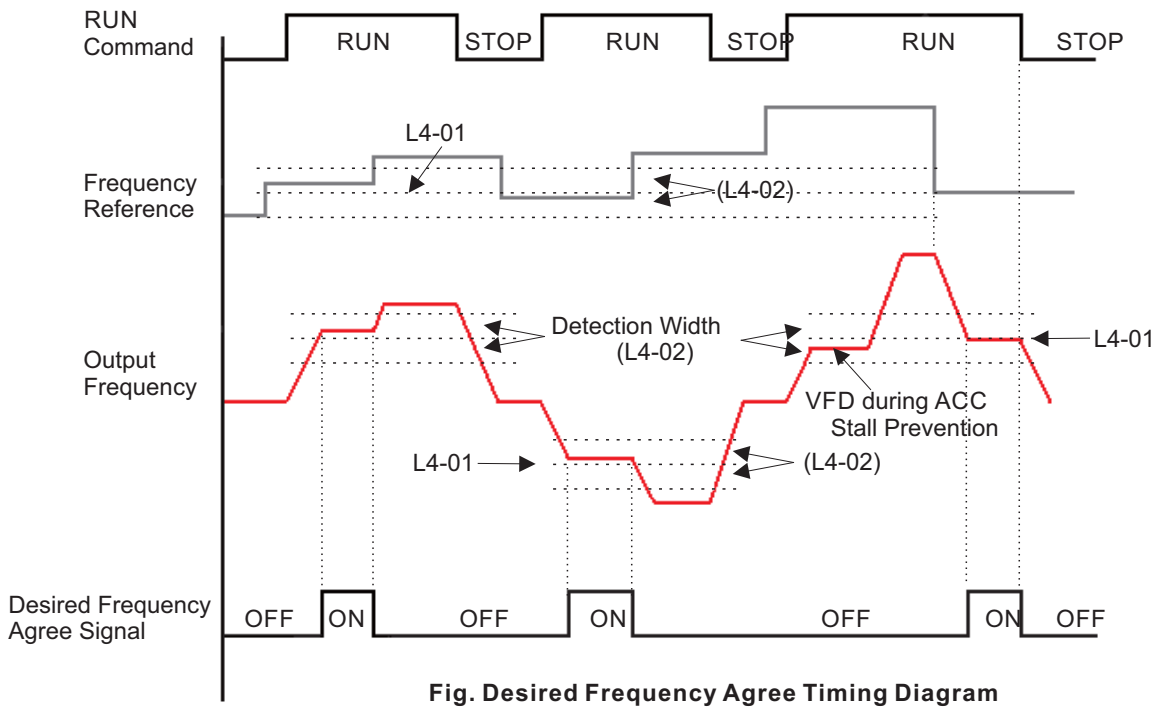

- Frequency Detection 1 (setting: "4")

Activates whenever the Output Frequency is at or above the Frequency Detection Level (L4-01). This is Effective during both Forward and Reverse Operation.

$$Fdet = Reference \geq L4-01$$

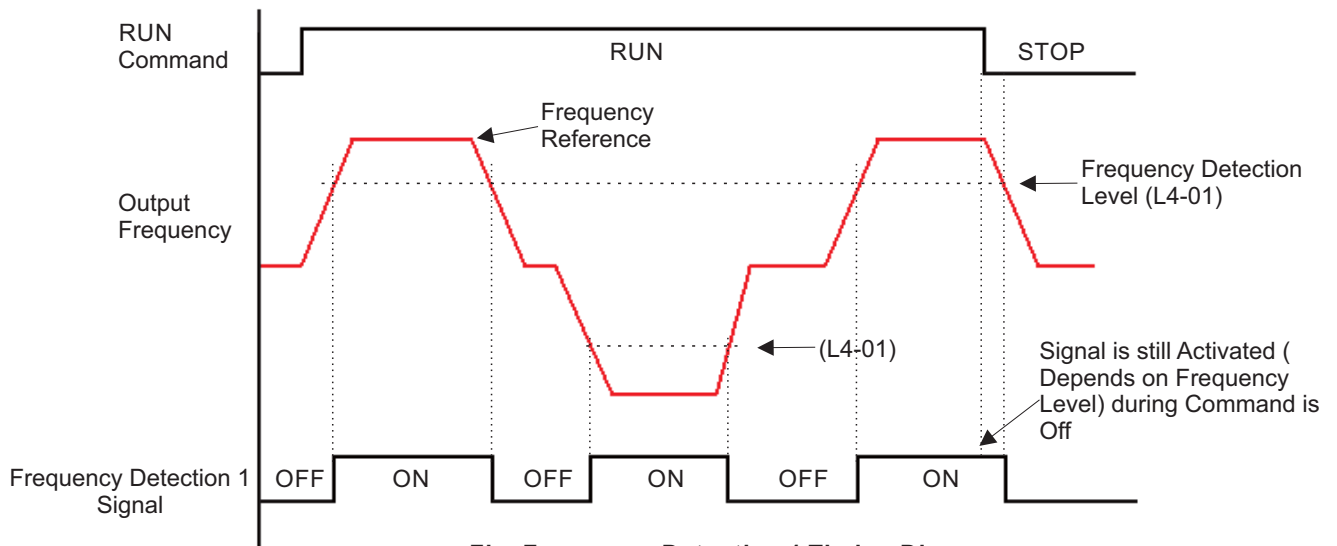

Fig. Frequency Detection 1 Timing Diagram

- Frequency Detection 2 (setting: "5")

Activates whenever the Output Frequency is at or below the Frequency Detection Level (L4-01). This is Effective during both Forward and Reverse Operation.

$$Fdet = Reference \leq L4-01$$

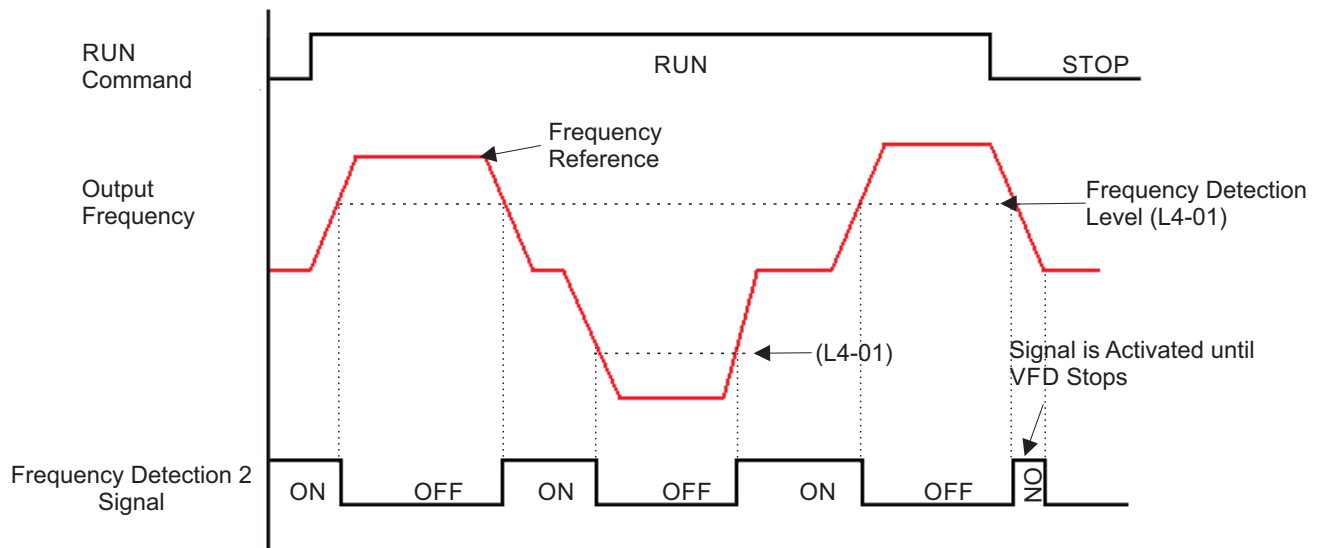

Fig. Frequency Detection 2 Timing Diagram

- Over Current Detection (setting: "17")

Activates during Over Current detection, see Parameter L6-01 to L6-03 in Page 5-44.

- Stall Prevention activates Detection (setting: "49")

Activates during Stall Prevention when VFD in Run Situation.

5.7.3 Analog Inputs: H3

H3-02 Terminal AVI Reference % Gain O O O X X

Setting Value
0~1000 (%) @ 100

Function Description
Set Terminal AVI Input Gain Level when the Reference Voltage is 10V, as Percentage of D2-01 (Frequency Upper Limit).

H3-03 Terminal AVI Reference % Bias O O O X X

Setting Value
0~100 (%) @ 0

Function Description
Set Terminal AVI Input Bias Level when the Reference Voltage is 0V, as Percentage of D2-01 (Frequency Upper Limit).

H3-09 Terminal ACI Function Selection X O O X X

Setting Value
ACI for PID Feedback Signal @ [0]
ACI for Frequency Bias of POT or AVI [1]
PID Feedback by AVI [2]

Function Description
[0]: PID Feedback Signal Input from Terminal ACI, PID runs according to B5-01.
[1]: When Frequency Reference comes through AVI or POT (set B1-01/ B1-10= 1 or 5), ACI could be the Bias of Input Reference.
[2]: PID Feedback Signal Input from Terminal AVI, PID runs according to B5-01.

H3-10 Terminal ACI Reference % Gain O O O X X

Setting Value
0~1000 (%) @ 100

Function Description
Set Terminal ACI Input Gain Level when the Reference **Current** is 20mA, as Percentage of selected Function.

H3-11 Terminal ACI Reference % Bias O O O X X

Setting Value
0~100 (%) @ 0

Function Description
Set Terminal AVI Input Bias Level when the Reference Voltage is 0/ 4mA (refer to set H3-13), as Percentage of selected Function.

H3-12 Terminal AVI Scan Time X O O X X

Setting Value
1~100 (X 2mS.) @ 50

Function Description
The Scan Time is 2m Second Cycle.
In Environment contains the Noise Interfere, Increase H3-12 can defense the obstruction, but the Signal Response should be Lower.

H3-13 AVI ACI Input Signal Selection X O O X X

Setting Value

Value	AVI	ACI	
[0]	0~10V	0~20mA	@ [0]
[1]	0~10V	4~20mA	
[2]	2~10V	0~20mA	
[3]	2~10V	4~20mA	

Function Description

- Signal is 0~10V or 0~20mA

$$V: F_{(Hz)} = \frac{V(v)}{10(v)} \times (D2-01)$$

$$I: F_{(Hz)} = \frac{I(mA)}{20(mA)} \times (D2-01)$$

- Signal is 2~10V or 4~20mA

$$V: F_{(Hz)} = \frac{V-2(v)}{10-2(v)} \times (D2-01), F_{(Hz)}=0 \text{ if } V \leq 2V$$

$$I: F_{(Hz)} = \frac{I-4(mA)}{20-4(mA)} \times (D2-01), F_{(Hz)}=0 \text{ if } I \leq 4mA$$

H3-14 Terminal AVI Bias +/- Selection O O O X X

Setting Value
Positive @ [0]
Negative [1]

Function Name
Terminal AVI Bias Positive/ Negative Selection

H3-15 AVI Normal/ Invert Selection O O O X X

Setting Value
Normal @ [0]
Invert [1]

Function Name
Terminal AVI Control Normal/ Invert Selection

H3-16 Terminal ACI Scan Time X O O X X

Setting Value
1~100 (X 2mS.) @ 50

Function Description
The Scan Time is 2m Second Cycle.
In Environment contains the Noise Interfere, Increase H3-12 can defense the obstruction, but the Signal Response should be Lower.

H3-17 Terminal ACI Bias +/- Selection O O O X X

Setting Value
Positive @ [0]
Negative [1]

Function Name
Terminal ACI Bias Positive/ Negative Selection

H3-18 ACI Normal/ Invert Selection O O O X X

Setting Value
Normal @ [0]
Invert [1]

Function Name
Terminal ACI Control Normal/ Invert Selection

H3-19 AI/ Pulse Train Reference Filter X O O X X

Setting Value
1~100 @ 30

Function Name
Analog/ POT/ Pulse Train(D6) Reference Hunting Filter Coefficient

● AVI/ ACI Bias

The Bias is not for Frequency only, the Definition is different depends on H3-14 Selection as below.

1. When H3-14=0 (Positive Value), the Frequency relates to the Analog Signal Input 0 is called "Reference Bias" (F_{BI}), the Bias is set for Frequency Reference.
2. When H3-14=1 (Negative Value), the Signal Input relates to the 0 Hz is called "Signal Bias" (S_{BI}), the Bias is set for Signal Input Level.

The Bias Value It is shown by "F_{BI}%".

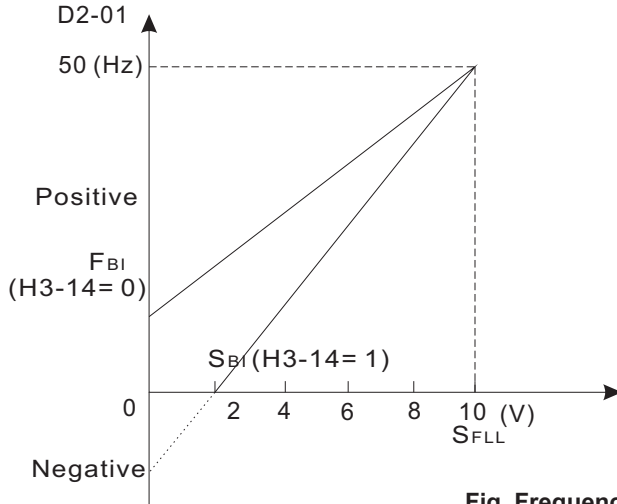

- When Bias set "+" (H3-14= 0)

$$F_{BI}\% = \frac{F_{BI}}{(D2-01)} \times 100\%$$

- When Bias set "-" (H3-14= 1)

$$F_{BI}\% = \frac{S_{BI}}{S_{FLL}} \times 100\%$$

In these Calculations, :

- F_{BI} —Reference Bias (Hz)
- F_{BI}% —Reference % Bias
- S_{BI} —Signal Bias (V or mA)
- S_{FLL} —10V or 20mA
- D2-01—Frequency Upper Limit

Fig. Frequency Reference Bias

● AVI/ ACI Reference % Gain

The relation between % Gain, Max. Requiring Frequency and Frequency Upper Limit is as the Calculation below.

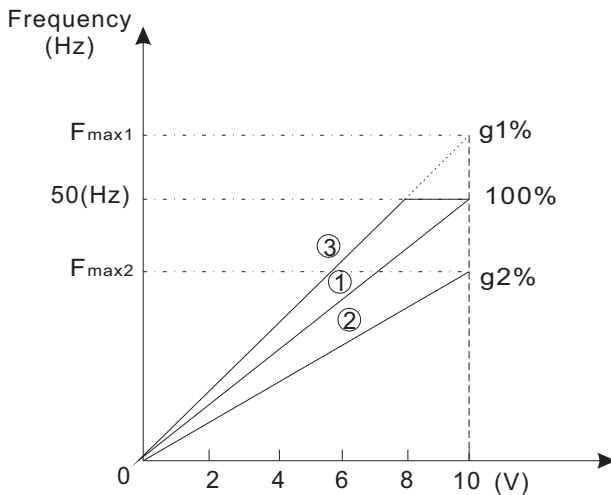

$$g\% = \frac{F_{max}}{(D2-01)} \times 100\%$$

In the Calculation:

- g% —Reference % Gain
- F_{max} —Estimated Max.Frequency
- D2-01—Frequency Upper Limit

Fig. Frequency Reference Gain

It is hereby the Estimated Max. Frequency (F_{max}) maybe not the same as Frequency Upper Limit (D1-01).

When g% < 100% (g2%), the Maximum VFD Output Actual Frequency is equal to the Calculated Value (F_{max2}), as ② in Fig. Frequency Reference Gain.

When g% > 100% (g1%), the Maximum VFD Output Actual Frequency is equal to Frequency Upper Limit (D2-01), as ③ in Fig. Frequency Reference Gain.

In the Fig. Frequency Reference Gain, the Line ① is 50Hz Base Pattern.

See Example below to know and get a correct % Bias & Bias Selection for your Application.

- i.e. +50% Bias with Normal Selection

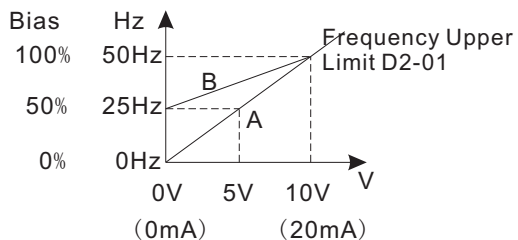

	H3-02	H3-03	H3-14	H3-15
A	100%	50%	0	0
B	100%	0%	0	0

- i.e. +50% Bias with Invert Selection

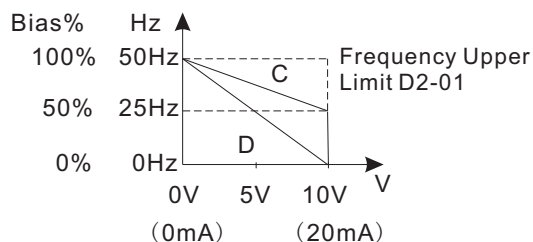

	H3-02	H3-03	H3-14	H3-15
C	100%	50%	0	1
D	100%	0%	0	1

- i.e. -50% Bias with Normal Selection

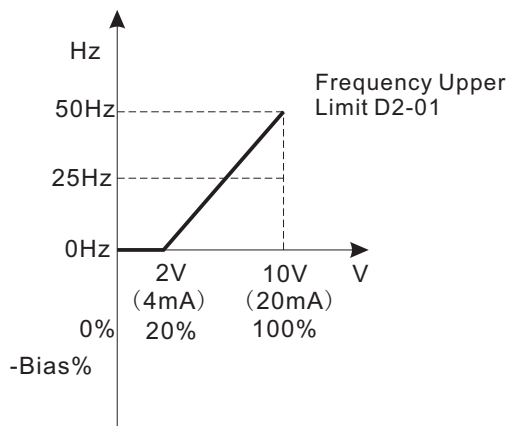

	H3-02	H3-03	H3-14	H3-15
E	100%	20%	1	0

- i.e. -50% Bias with Invert Selection

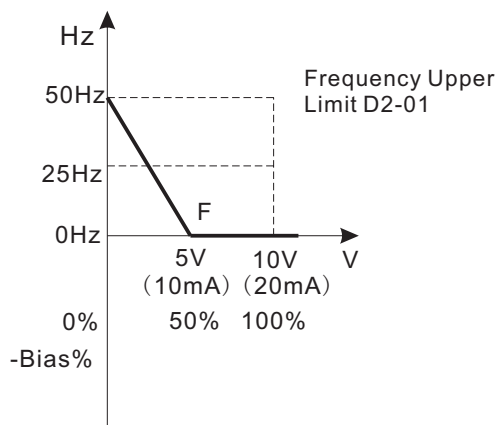

	H3-02	H3-03	H3-14	H3-15
F	100%	50%	1	1

5.7.4 Analog Outputs: H4

H4-01 AO Function Selection **O O O X X**

Setting Value

Frequency Reference	[1]
Output Frequency	@ [2]
Output Current	[3]
Output Voltage	[6]
DC Bus Volatge	[7]

Function Name

Analog Output Terminal AO Function Selection

Function Description

Terminal AO Output 0~10VDC, uses the H4-02~ H4-10 do some adjusting if there is some difference between a additional Device measured Value and VFD Output Value.

Maximum Output Voltage is 10VDC.

H4-02 Terminal AO % Gain **O O O X X**

Setting Value

0~1000 (%) @ 100

Function Description

Sets the Terminal AO Output Gain for the Analog Output Monitors. To obtain the Output Level, multiply the Monitor Output Level by the Gain Value set in H4-02.

H4-03 Terminal AO Reference % Bias **O O O X X**

Setting Value

0~100 (%) @ 0

Function Description

Sets the Terminal AO Output Bias for the Analog Output Monitors. To obtain the Output Level, multiply the Monitor Output Level by the Gain Value set in H4-02, then add the Bias Value set in H4-03 to H4-10.

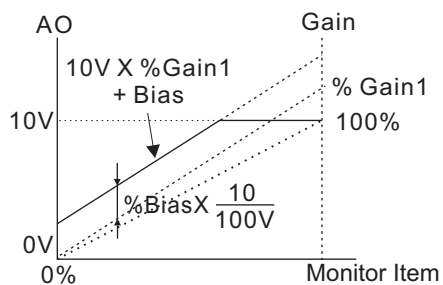
**H4-09 Terminal AO Bias +/- Selection** **O O O X X**

Setting Value

Positive @ [0]
Negative [1]

Function Description

Refer to Analog Inputs: H3

H4-10 AO Normal/ Invert Selection **O O O X X**

Setting Value

Normal @ [0]
Invert [1]

Function Name

Terminal AO Control Normal/ Invert Selection

Function Description

Refer to Analog Inputs: H3

5.7.5 Serial Communication (Modbus) Set-up: H5

The VFD uses Communication Terminals A,B,SG to communicate via MODBUS Protocol.

H5-01 Modbus Station Address X X X X X

Setting Value
1~32 @ 1
Function Name
Serial Communication Station Address
Function Description
Selects a Station Address for Identification of the VFD during Serial Communication.

H5-02 Modbus Baud Rate X X X X X

Setting Value
1200 Baud [0]
2400 Baud [1]
4800 Baud [2]
9600 Baud @ [3]
19200 Baud [4]
Function Name
Serial Communication Baud Rate
Function Description
Selects the Baud Rate at which the VFD Serially Communicates with External Devices.

H5-03 Modbus Parity Selection X X X X X

Setting Value
No parity @ [0]
Even parity [1]
Odd parity [2]
Function Name
Serial Communication Parity Selection
Function Description
Selects the Transmission Parity for the MODBUS Port.

H5-04 Stop Method Modbus Error X X X X X

Setting Value
[0]: Ramp to Stop according to the Time set in C1-02. @ [0]
[1]: Coast to Stop. [1]
[2]: Fast-stop according to the time set in C1-04. [2]
[3]: Alarm Only Continuous Operation
Function Name
Stopping Method After Communication Error
Function Description
Selects the Stopping Method after a Transmission Error is detected, the LCP shows "CE".

H5-06 Modbus Response Delay Time X X X X X

Setting Value
1~16 (X 2mS.) @ 5
Function Name
Transmission Response Delay Time
Function Description
Set this Value for the Time between VFD received Data and Send Data.

H5-08 ASCII/ RTU Code Selection X X X X X

Setting Value
RTU Code @ [0]
ASCII Code [1]
Function Name
Modbus ASCII/ RTU Protocol Code Selection
Function Description
Refer to YD101 MODBUS Manual.

H5-09 Modbus Stop Bit Selection X X X X X

Setting Value
1 Stop Bit @ [0]
2 Stop Bit [1]
Function Name
Serial Communication Stop Bit Selection

H5-10 Modbus Data Format Selection X X X X X

Setting Value
8 Bits Data @ [0]
7 Bits Data [1]
Function Name
Serial Communication Data Format Selection

H5-11 MODBUS Time Out Detection X O O X X

Setting Value

0.0~25.5 @ 0.0

Function Name

Serial Communication Time Out Detecting Time

Function Description

Set the MODBUS Time Out Detection Function. After Initial Communication begins, if Communication is Interrupted for Longer than H5-11, then a Communication Fault will occur. During a Communication Fault, the Fault Code "CE" will be displayed. If set Value=0.0, the Time Out Detection Function is disabled.

Run Mod Initial V/F o2-4

H5-12 Number of MODBUS Error X O O X X

Setting Value

1~20 @ 3

Function Name

Allowed Number of Serial Communication Error

Function Description

When the Number of VFD Communication Data Fail is over than H5-12, the Error Code "OPE14" will be displayed.

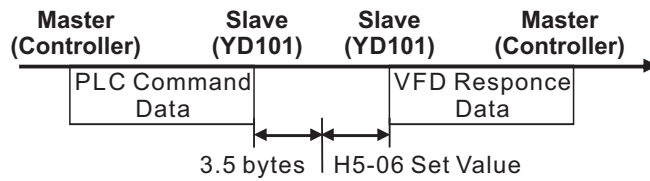

Fig. Transmission Response Delay

5.8 保护功能, 参数 (L)

5.8.1 电机保护功能: L1

L1-06 电机 OL1 选择 X O O X X

取值

Motor Overload Detection is enabled. [0]
Motor Overload Detection is disabled. @ [1]

功能

Motor Protection Fault Selection (OL1)

功能说明

The Motor Electronic Thermal Overload Function estimates Motor Temperature, based on Rated Current setting (E2-01) and Time, to protect the Motor from Overheating.

When the Electronic Thermal Overload Relay is Activated, an "OL1" Error occurs, Shutting OFF the VFD Output and preventing Excessive Overheating in the Motor. As long as the VFD is Powered Up, it continues to calculate the Motor Temperature.

L1-07 电机类型选择 X O O X X

取值

Self Cooling @ [0]
Force Cooling Fan [1]

功能

This Setting for the Type of Motor Ventilation. Affects the Characteristic of Motor Overload Protection by Lowering the Actual Overload Current at Lower Frequency (Speeds).

[0]: With a Motor with a Shaft Mount Fan, the Cooling Ability will drop when Motor Runs at Low Frequency (Speed), therefore the VFD's OL1 Protection responds quickly at Low Frequency.

[1]: VFD's OL1 Protection Level is the same at High Speed and Low Speed.

Note: If set L1-07= 0 (Motor Self Cooling), please Set T1-05 to Real Rated Frequency of Motor that is used.

L1-08 电机过载保护选择 X O O X X

取值

OL= 150%, 1 Minute @ [0]
OL= 123%, 1 Minute [1]
OL= L1-10, Time= L1-11 [2]

功能

[0]: It is for General Application, the Motor can continue Operation if the Load is under 103% of Motor Rating. The Motor Operates 1 Minute only if Load is 150% Motor Rating.

[1]: This is for HVAC (Centrifugal Fan or Pump) Application, the Motor can continue Operation if the Load is under 113% of Motor Rating. The Motor Operates 1 Minute only if Load is 123% Motor Rating.

[2]: It is for Customize Requiring, the OL1 Level and Time depends on Set L1-10 and L1-11. (This is available for Firmware V0.7 and Later.)

L1-09 过载保护动作 X O O X X

取值

VFD Shuts Off after OL1 Detected. @ [0]
VFD Continue Operation after OL1 Detected. [1]

功能

Stop Method after OL1 Protection Fault Selection

功能说明

[0]: VFD Output Shuts Off when the OL1 is detected, a "OL1" Signal Blinks on the LCP. If Operation is needed, please do the Reset by Terminal or RESET Key of LCP.

[1]: VFD Continue Operation when the OL1 is detected, a "OL1" Signal Blinks on the LCP. The "OL1" Signal will Off when the Load (Current) is dropped lower than L1-08 selected Value.

L1-10 电机电子继电器保护准位 X O O X X

取值

30~200 (%) @ 100

功能

The Actual OL Protection Level will be 1.2 Times of L1-10 set Value voluntarily. i.e. if set L1-10= 100%, the Motor will stop after L1-11 set Time if Load is 144% Motor Rating.

This Parameter is Enabled when L1-08= 2.

L1-11 电机电子继电器保护动作时间 X O O X X

取值

0.1~100.0 (Sec.) @ 20.0

功能

This Parameter is Enabled when L1-08= 2.

- When operating with one VFD connected to one Motor, an External Thermal Relay is not needed.
- When operating Several Motors with one VFD, Install a Thermal Relay on Each Motor. In this case, set Parameter L1-06 to "0".
- The Motor Protection Function may not protect a Motor when the Power Supply is turned ON and OFF Frequently, because the Thermal Value is Reset Each Time that the Power is turned OFF.
- If the Overload OL1 Pre Alarm (1F) is set in one of the Multi-function Outputs (H2-01 to H2-03), the Output will be turned ON when the Electronic Thermal Value reaches 90% of the Overload Detection Level.

5.8.2 Power Loss Ridethrough: L2

When Momentary Power Loss occurs, Operation can Restart Automatically, according to the Setting of the Following Parameters.

L2-01 Power Loss Selection X O O X X

取值

Disabled @ [0]
 Enabled [1]
 Enabled (CPU) [2]

功能

Momentary Power Loss Ridethrough Selection

功能说明

Selects whether the VFD Stops when Power Loss is Detected or “Rides Through” a Momentary Power Loss. When Ridethrough Operation is Selected (Enabled), Speed Search may start from the Current Output Frequency.

[0]: Momentary Power Loss Ridethrough is Disabled. When Momentary Power Loss is detected a Fault Contact trips Stopping the VFD, and “LV-C” Signal is shown on LCP.

[1]: Momentary Power Loss Ridethrough is Enabled for the Time set in L2-02. When Momentary Power Loss is detected a Fault Contact does not trip. If Power is Restored within the Time set in L2-02, VFD Restarts 0.5 Second later, and the Number of Restart is Unlimited.

If Power is not Restored within the Time set in L2-02, a Fault Contact trips Stopping the VFD, and “LV-C” Signal is shown on LCP.

[2]: Momentary Power Loss Ridethrough is Enabled within the Control Logic Time, regardless of the Time set in L2-02. The Control Logic Time differs depending on VFD Capacity. If Power is not Restored within Long Time, VFD Stops. If Power is Restored before VFD’s LCP goes Off, VFD Restarts according to Set B1-02, L5-03 and Terminal Signal Status.

L2-02 Momentary Power Loss Time X O O X X

取值

0.0~2.0 (Sec.) @ 0.5

功能

Momentary Power Loss Ridethrough Time

功能说明

Due to a Huge Load Equipment is added to the same Input Power Circuit with VFD, it could result in the Voltage Drops suddenly below the Under Voltage Level, the VFD will Shot off Output at once. If the Power Supply Voltage Level recovers in the Time set L2-02, it will Spin Start Tracing from the Tripped Frequency, or the VFD will trip with ‘LV-C’ Signal shown in LCP.

Sets the Ridethrough Time allowed before the VFD trips, after Momentary Power Loss. This setting is activated when L2-01 is set to “1”. If Power is Restored within this Time, Operation Restarts Automatically.

Note : When B1-02=1(Run Command by Terminal), please Turn the Run Signal & Input Power Off if Power Loss for a long Time. The VFD may Start or Restart if Power is Restored, it could result in Serious Injury or Equipment damaged.

5.8.3 Stall Prevention: L3

This Function Automatically Adjusts the Output Frequency, Acceleration and/or Deceleration Rates in order to Continue Operation without Tripping or “Stalling” the VFD.

L3-01 Acceleration Stall Prevention X O O X X

取值

Disabled. @ [0]
Enabled. [1]

功能

Stall Prevention Selection During Acceleration

功能说明

[0]: Stall Prevention/ Current Limit during Acceleration is Disabled. The VFD increases the Output Frequency at the set Acceleration Rate. If the Acceleration Rate is too Fast for the Load Condition the VFD may trip on Overcurrent (OC) or Overload (OL).

[1]: Stall Prevention/ Current Limit during Acceleration is Enabled. The Acceleration Rate is Automatically Reduced according to Motor Current to prevent Stalling during Acceleration. The Acceleration Time may be Longer than the Set Value (C1-01 or C1-03).

L3-02 ACC Stall Prevention Level X O O X X

取值

10~300 (%) @ 150

功能

Stall Prevention Level During Acceleration

功能说明

The Stall Prevention/ Current Limit Level during Acceleration is set as a Percentage of VFD Rated Current.

A setting of 200% disables Current Limit during Acceleration. During Acceleration, if the Output Current Exceeds this Current Limit Level (L3-02), Acceleration Stops and Frequency is Maintained.

When the Output Current Decreases below this Current Limit Level (L3-02), Acceleration Restarts.

In General, no need to make a Change for L3-02.

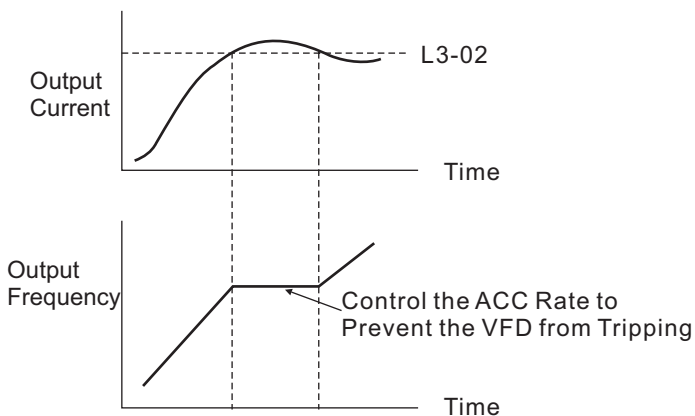

Fig. Stall Prevention Function During ACC (L3-01= 1)

L3-04 Deceleration Stall Prevention X O O X X

取值

Disabled. @ [0]
Enabled. [1]

功能

Enabled with Limited Function.

功能

Stall Prevention Selection During Decelerating

功能说明

An Excessively Short Deceleration Time will Generate an Overvoltage Fault (OV) and the VFD will Stop. Please uses the Additional Braking Device (such as Braking Resister/ Braking Unit or Module) if needed.

For Set Value [1] or [2], The DC Bus Voltage Level and Output Current are Monitored and the Deceleration Rate is Automatically Extended to Prevent an Overvoltage or Overcurrent Condition. This Deceleration Rate may be Longer than the Set Value (C1-02 or C1-04).

[0]: Additional Braking Device used, VFD stop the Motor follow Set Value (C1-02 or C1-04)

[1]: Enabled for VFD DEC. to Stop, or VFD DEC for Speed change during Operation.

[2]: Enabled when VFD DEC for Speed change during Operation only, it is Disabled for VFD DEC to Stop. Set [2] is available for Firmware V.0.7 and Later.

Please Refer to Parameter L3-07 for Deceleration Current Limit Setting.

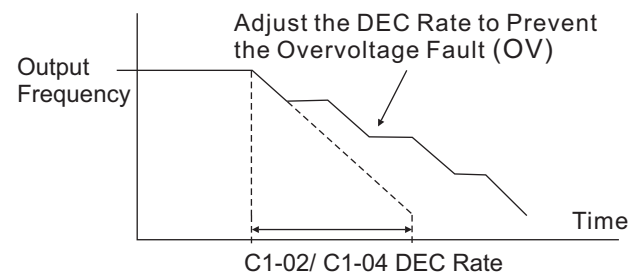

Fig. Stall Prevention Function During Deceleration (L3-04)

L3-05 Running Stall Prevention X O O X X

取值

Disabled. @ [0]
Enabled. [1]

功能

Stall Prevention Selection During Running

功能说明

[0]: Stall Prevention/ Current Limit during Running is Disabled. An Excessively Load change will generate an Overload (OL) or Overcurrent (OC) Fault and the VFD will Stop.

[1]: Stall Prevention/ Current Limit during Running is Enabled. When the VFD Output Current Exceeds the Current Limit Level (L3-06), for More than 100ms during Speed Agree the Output Frequency is Decreased according to Deceleration Time (C1-02 or C1-04), and this can Prevent Stalling. When the Load Condition is Stabilized the VFD Accelerates to the Previous Frequency.

L3-06 Running Stall Prevention Level X O O X X

取值

10~300 (%) @ 150

功能

Stall Prevention Level During Running

功能说明

The Stall Prevention/ Current Limit Level during Running is set as a Percentage of VFD Rated Current.

A setting of 200% disables Current Limit during Running. During Speed Agree, if the Output Current Exceeds this Current Limit Level during Running, then Deceleration Starts.

When the Output Current Exceeds this Current Limit Level (L3-06), Deceleration Continues. When the Output Current Decreases below this Current Limit Level (L3-06), Acceleration Starts, Up to the Set Frequency.

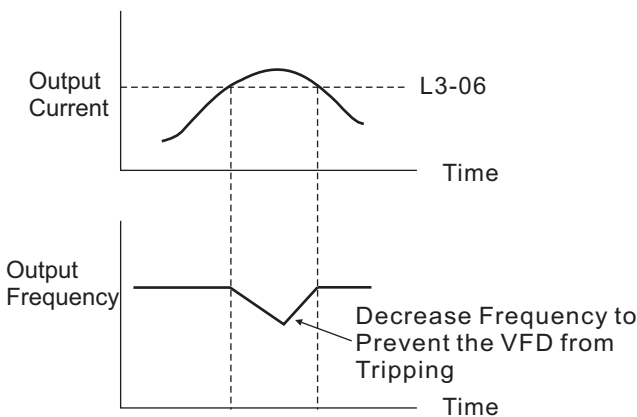

Fig. 1 Stall Prevention Function During Running (L3-05= 1)

L3-07 DEC Stall Prevention Level X O O X X

取值

10~300 (%) @ 150

功能

Stall Prevention Level During Deceleration

功能说明

The Stall Prevention/ Current Limit Level during Deceleration is set as a Percentage of VFD Rated Current.

A setting of 200% disables Current Limit during Deceleration. During Deceleration, if the Output Current Exceeds this Current Limit Level (L3-07), Deceleration Stops and Frequency is Maintained.

When the Output Current Decreases below this Current Limit Level (L3-07), Deceleration Restarts.

In General, no need to make a Change for L3-07.

Refer to L3-04 for more Description about Deceleration Stall Prevention.

L3-08 Running Over Volt. Prevention X O O X X

取值

Disabled @ [0]

Enabled: Increase Output FRQ [1]

Enabled: Increase DEC Time [2]

功能

Over Voltage Prevention During Running Selection

功能说明

[1]: Increases the VFD Output Frequency Automatically when DC Bus Voltage is Over than L3-09 Set Value.

[2]: Enlarge the VFD Decelerating Time Automatically when DC Bus Voltage is Over than L3-09 Set Value.

L3-09 Running OV. Prevention Level X O O X X

取值

350.0~ 390.0 VDC...(200V Class) @ 380.0

700.0~ 780.0 VDC...(400V Class) @ 760.0

功能

Overvoltage Prevention Level During Running

功能说明

Refer to Parameter L3-08

L3-10 Deceleration OV. Restraint Gain X O O O X

取值

0~20 @ 10

功能

Overvoltage Restraint Gain During Deceleration

功能说明

This Parameter can increase the Brake ability for V/F Control Mode.

When Stall Prevention During Deceleration is Enabled, Enlarge this Set Value if Actual Deceleration Time is too long or "OV" Fault occurred.

5.8.4 Reference Detection: L4

Refer to section H2, Digital Outputs on Page 5-28, for More Detailed Information .

L4-01 Frequency Agree Level O O O X X

取值
0.00~650.00 (Hz) @ 0.00

功能
Frequency Agree Detection Level

功能说明

Sets the Detection Level for the Desired Frequency Agree and Frequency Detection 1 and 2 Functions. The Set Detection Level is Effective during Both FWD and REV Operation.

L4-02 Frequency Agree Width O O O X X

取值
0.00~30.00 (Hz) @ 2.00

功能
Frequency Agree Detection Width

功能说明

Sets the Detection Width for Frequency and Desired Frequency Agree 1 and Frequency Detection 1 and 2 functions.

5.8.5 Automatic Restart: L5

After a Fault occurs, the VFD and its Fault Detection Circuit can be Reset. The Automatic Restart Function allows the VFD to Continue Operation after Certain Faults. .

L5-01 Number of Automatic Restart X O O X X

取值
0~10 @ 0

功能
Number of Automatic Reset then Restart Attempt

功能说明

Sets the Number of Automatic Restart Attempts. Setting to "0" Disables this Function. Automatic Restart Function is used Frequently that may Result VFD Damaged.

The Number of Restart Attempts is reset to 0 when:

- A Fault does not Occur for More than 10 Minutes after Restart.
- A Fault Reset Command is Input from the Control Circuit Terminal or the Digital Operator.
- Power is Cycled.

L5-03 Automatic Restart Method X O O X X

取值

Speed Search @ [0]
Direct Start [1]

功能
Starting Method after Automatic Restart Attempts

功能说明

[0]: When the Fault is Reset Automatically and Speed Search Starts from the Previous Output Frequency before the Fault Occurred.

[1]: When the Fault is Reset Automatically and VFD Starts from the Zero Speed and according to the Acceleration Time accelerate to the Set Frequency.

L5-04 Automatic Restart Waiting Time X O O X X

取值
0.0~800.0 (Sec.) @ 0.0

功能
Waiting Time of Automatic Restart Attempts

功能说明

- If L5-04= 0.0, the Automatic Restart is Disabled.
- When L5-04> 0, L5-01= 0
The Fault is Reset Automatically after Fault Occurs 0.5 Second later. Speed Search Starts from the Previous Output Frequency before the Fault Occurred, then Accel/ DEC to the Current Frequency Reference.
- When L5-04> 0, L5-01> 0
A Fault Occurs, VFD Outputs Shuts Off for L5-04 Set Time. While the L5-04 Time elapses, the Fault is Reset Automatically and Speed Search Starts to the Current Frequency Reference.
- When L5-04> 0, L5-01> 0
Automatic Restart is not Disability during Deceleration to Stop and DC Braking.

L5-05 Restart Mode Selection X O O X X

取值

Restart Command is disabled when Run Command Activates. @ [0]

Restart Command is No Matter with Run Command Status. [1]

功能

If L5-05= 0, the Run Command Signal must be Inactivated after a Fault Detected then Reset the Fault. Otherwise the Restart Function would be disabled.

L5-06 Direct Start after Power Up X O O X X

取值

Enable if Run Command is On. [0]

Disable if Run Command is On. @ [1]

功能

[0]: When the B1-02/ B1-09= 2(Terminals) , if Run Command Signal is On and Mains Power Up, the VFD will Start. Yolico Recommend turning Run Command Off if the Mains is Off, avoids the Human Injury or Machine Damage after Power Up again.

[1]: When the B1-02/ B1-09= 2(Terminals) , if Run Command Signal is On and Mains Power Up, the VFD won't Start, a "STP1" Blinks on LCP. Starts VFD by Off-On Run Signal.

L5-07 Direct Start Delay Time	X	O	O	X	X
取值					
2.0~300.0 (Sec.)					@ 2.0
功能					
Direct Start Delay Time after Power Up					
功能说明					
When Run Signal is activated and L5-06= "0", VFD Starts after L5-07 set Time if Mains is On.					

L5-08 KEB Deceleration Time Setting	Run	Mod	Initial	V/F	o2-4
取值	X	O	O	X	X
0.0~25.0 (Sec.)					@ 0.0
功能					
Kinetic Energy Braking Ridethrough Deceleration Time Setting					
功能说明					

This Parameter allows for setting the Deceleration Time for Load Inertia Ridethrough. This setting is used in Conjunction with Multi-function Contact Inputs set for KEB Ridethrough (H1-__ = "85"), after Momentary Power Loss.

When the KEB Deceleration Time is set to "0.0", KEB Ridethrough Functions as Normal, when the KEB Deceleration Time is set to any Value other than "0.0", KEB Ridethrough for Systems use is Enabled.

Refer to Page. 5-23 "KEB Ridethrough Power Restore (setting: 85) for more Information.

i.e. 200V Class

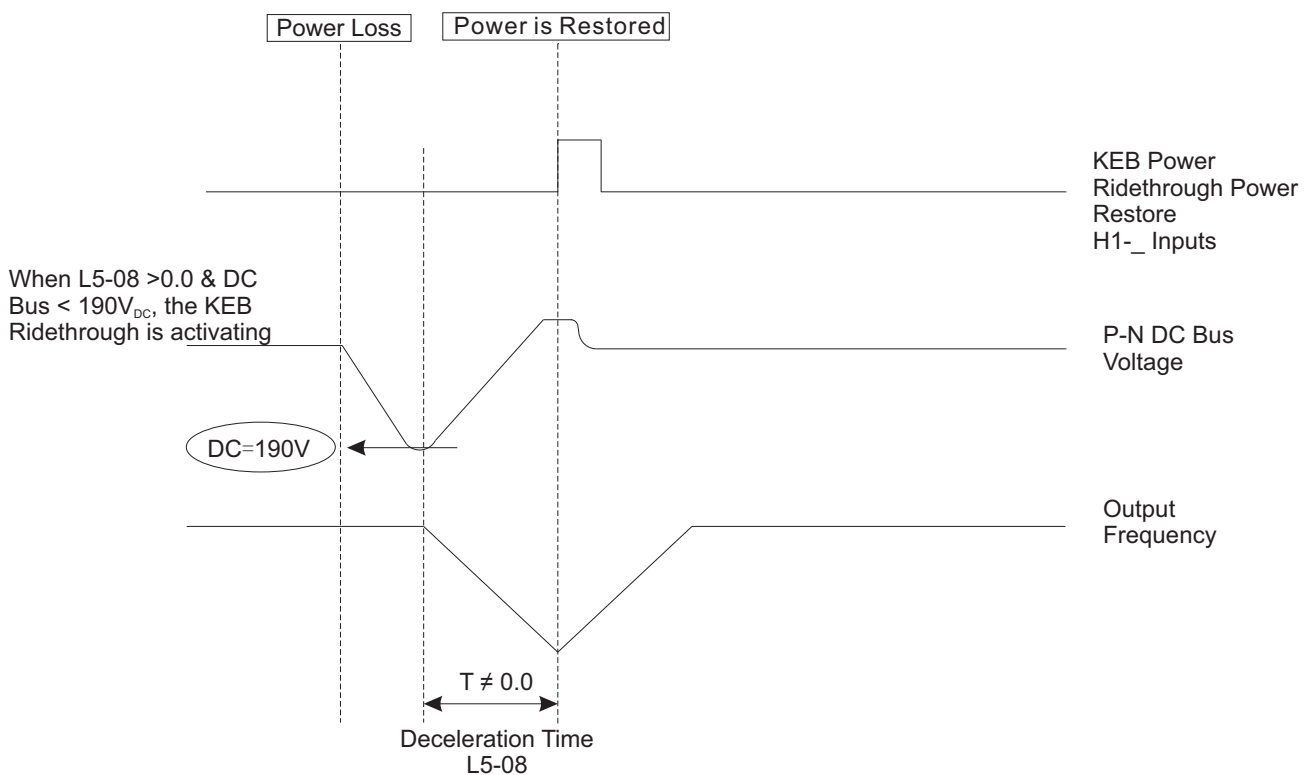

Fig. KEB Ridethrough Timing Diagram

Note:

1. Set L5-08 > 0.00, when the DC Bus Voltage is Lower than 190VDC, KEB Ridethrough activates.
2. If Power is Restored till the DC Bus Voltage is ≥ 220VDC (200VAC Class, 440VDC for 400VAC Class) and Rising Edge of KEB Ridethrough Power Restored Signal is activating, VFD accelerates to the Previous Frequency Reference according to Acceleration time (C1-01/ C1-03).

L5-09 DC Bus LV Detection Level	X	O	O	X	X
取值					
150.0~210.0 (VDC)					@ 190
300.0~420.0...(VDC)					@ 380
功能					
DC Bus Undervoltage Detection Level					

5.8.6 Over Current Detection: L6

L6-01 Overcurrent Detection Selection X X X X X

取值	
Disabled	@ [0]
Enabled whenever at Speed Agree Level. Continue Running after Detection.	[1]
Enabled always. Continue Running after Detection.	[2]
Enabled whenever at Speed Agree Level. Coast to Stop after Detection.	[3]
Enabled always. Coast to Stop after Detection.	[4]

功能

Over Current Detection Function Selection

功能说明

This Parameter must combine with T6-02, T6-03 and Digital Outputs (H2).

[1] & [2]: The VFD will not Stop after Over Current Detection. LCP is flashing for Warning.

[3] & [4]: The VFD stops after Over Current Detection, Fault Relay is activated.

To detect Over Current during ACC/DEC, please set to [2] or [4].

L6-02 Overcurrent Detection Level X X X X X

取值	
10~200 (%)	@ 150

功能

Over Current Detection Level

功能说明

Set the Level as a percentage of T1-04 Motor Rated Current as 100%

L6-03 Overcurrent Detection Time X O O X X

取值	
0.0~10.0	@ 0.1

功能

Over Current Detection Delay Time

功能说明

The Over Current Detection Delay Time inserts a Delay, between the Time Motor Current exceeds the L6-02 and when the Over Current Detection L6-01 is Enabled.

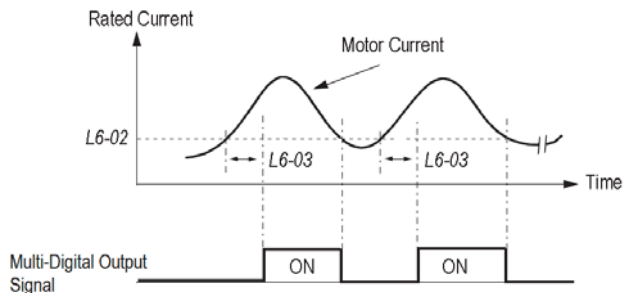

5.8.7 Hardware Protection: L8

L8-04 Built-in Cooling Fan Selection X O O X X

取值	
Auto Run by Internal Thermal	[0]
Runs during VFD Runs	@ [1]
Runs Always	[2]
Stops	[3]

功能

Built-in Cooling Fan Operation Mode Selection

功能说明

[0]: Cooling Fan Runs when Specific Temperature of IGBT/ Heat Fins is detected. This Setting could Increase the Life of Fan.

[1]: Cooling Fan Runs when VFD is in Runs Situation.

[2]: Cooling Fan Runs always when Mains Power Up.

[3]: Cooling Fan Stops always.

Note: This Parameter is available for Frame A1 & A2.

L8-17 Carrier Frequency Auto Reduce X O O X X

取值	
Disabled.	@ [0]
Enabled.	[1]

功能

Carrier Frequency Auto Reduce when Temperature Rise

功能说明

Set L8-17= 1, when Monitor U1-46 is Higher than 100°C, the Carrier Frequency will Automatic Reduce to 4k Hz, and Return to Original Set Value after the Temperature drop to 90°C.

If C6-01 set Value is $\leq 4\text{kHz}$, the Function of L8-17 is Useless.

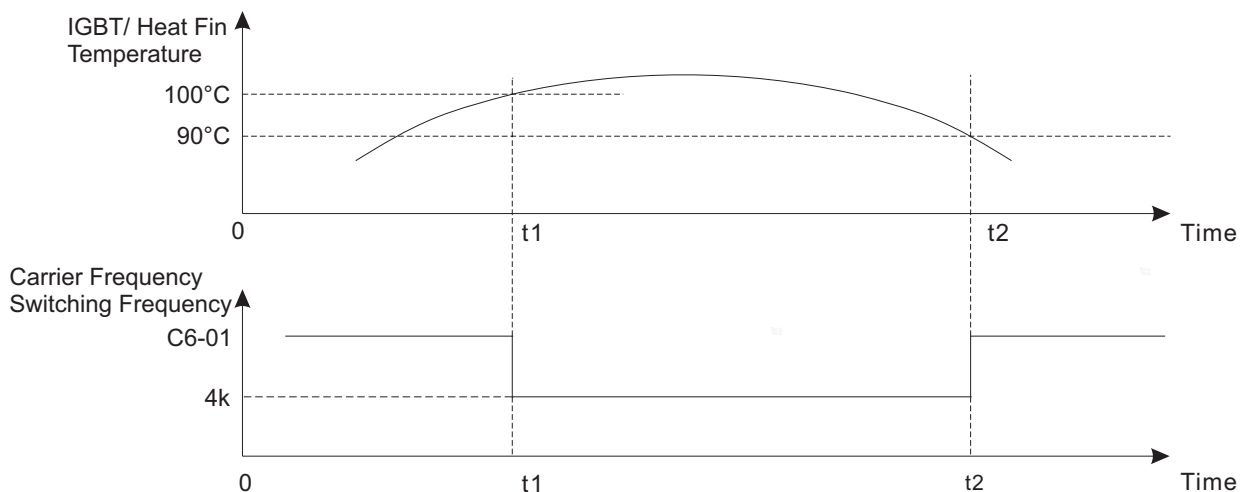

5.9 Operator, Group (O)

5.9.1 Monitor Selection: O1

O1-02 Monitoring after Power Up X O O X X

取值	
None	@ [0]
Frequency Reference	[1]
Output Frequency	[2]
Output Current	[3]
Output Voltage	[4]
DC Bus Voltage	[5]

功能

Monitor Selection after Power Up

功能说明

When the Power is turned On, the Frequency Reference will appear and Blink in the Unit's Data display if the Factory Settings are being used. Change the Setting of Parameter O1-02 to display an Item other than the Frequency Reference in Fully Lit at Startup.

O1-06 RPM Scale for Monitoring O O O X X

取值	
0~65535	@ 1500-50Hz
	@ 1800-60Hz

功能

RPM Scale for Monitoring Frequency

功能说明

This Parameter determine the Set Value at 100% Motor Rated Frequency (T1-05)

i.e. set Value to 1500, at Motor 50Hz, LCP shows 750 when Output 25Hz.

Refer to O1-07 for more Information.

O1-07 Scale for Monitoring Selection O O O X X

取值	
Output Frequency	@ [0]
5 Digits of RPM displayed as 00000	[1]
5 Digits of RPM displayed as 0000.0	[2]
5 Digits of RPM displayed as 000.00	[3]
5 Digits of RPM displayed as 00.000	[4]

功能

Scale Setting for Frequency Monitoring

功能说明

i.e.1, set O1-07= 1, O1-06=1500, 100% Frequency Reference is displayed as 1500

i.e.2, set O1-07= 2, O1-06=1500, 100% Frequency Reference is displayed as 150.0

5.9.2 Key Selection: O2

O2-02 LCP Stop Key Selection X O O X X

取值	
Enable	@ [0]
Disable	[1]

功能

STOP Key During External Command Operation

功能说明

Enables/ Disables the Digital Operator STOP Key, during Operation from the External Terminals and during Serial Communication.

[0]: The LCP STOP Key is always Enabled even during External Terminal Operation and Serial Communication.

[1]: The LCP STOP Key is disabled when Run Command does not Come from the Digital Operator.

O2-04 Inverter Model X O X X X

取值	
20P5~ 4075	@ VFD Model Dependent

功能

VFD Capacity Checking Number

功能说明

Checks the VFD Capacity, according to Model Number. Control Parameters with Defaults Specific to the VFD Capacity are set Automatically (i.e. Carrier Frequency, Motor Data, etc.). This Parameter is Reserved for the use of Factory, can not change.

O2-05 LCP M.O.P. Mode Selection X O O X X

取值

M.O.P Disable @ [0]
M.O.P. Enable [1]

功能

Digital Operator M.O.P. Mode Selection

功能说明

Selects whether the "ENTER" Key is used when the Frequency Reference is set by the Digital Operator. The Digital Operator can Simulate a Motor Operated Potentiometer (**M.O.P.** or **MOP**) by setting this Parameter.

[0]: The LCP M.O.P. Mode is Disabled. The VFD accepts the Frequency Reference when the "ENTER" Key is depressed.

[1]: The LCP M.O.P. Mode is Enabled. The VFD accepts the Frequency Reference as soon as changes are made with the Arrow keys, without the "ENTER" Key being depressed.

O2-08 Accumulative Worked Time X O X X X

取值

Cumulative Hours at Power On @ [0]
Cumulative Hours at Running [1]

功能

Accumulative Worked Time Selection

功能说明

Selects this Parameter for the Monitors U1-48, U1-49. The showed Value in U1-48 is 0~23, once the U1-48 Value is Over than 23, it should bring it to U1-49, then U1-48 becomes "0" and Value of U1-49 plus "1".

<u>U1-49</u>	<u>U1-48</u>
<u>(Days)</u>	<u>(Hours)</u>
:	:
<u>0~65535</u>	<u>0~24</u>

Run|Mod|Initial|V/F|o2-4

O2-10 Allow Worked Days X O X X X

取值

0~65535 (Days) @ 0

功能

VFD Allowed Workinging Days

功能说明

Set this Parameter to Prohibit the VFD Operating when U1-49 ≥ O2-10.

Set Value "0" to disable this Function.

O2-11 Parameter Lock by Password X O X X X

取值

All Parameters Monitored Only @ [0]
O2-10 Monitored Only [1]

功能

Parameter Lock-out Selection by Password Protection

功能说明

Refer to A1-04 to Lock-out Parameter(s) as below.

[0]: All Parameters is accessed to be Monitored only, it can not be Changed.

[1]: Only O2-10 is Locked-out just can be Monitored, The Parameters Else are accessed to be Changed.

5.10 Process, Group (P)

5.10.1 Auto Process Operation: P1

P1-00 Auto Process Selection X O O X X

取值

Auto Process Disable @ [0]
 Executes 1 Cycle Operation then Stop [1]
 Continuously Executes Cycles Operation [2]
 Executes 1 Cycle Operation then Keep Running [3]
 at Last Process Speed
 Executes 1 Cycle Operation then Stop [4]
 Continuously Executes Cycles Operation [5]
 Executes 1 Cycle Operation then Keep Running [6]
 at Last Process Speed

功能

Auto Process Operation Mode Selection

功能说明

[1], [2], [3]: VFD will Start Up from the Speed of before VFD Stop, if Start Command given again.

[4], [5], [6]: VFD will Start Up from the 1st Process Speed after VFD Stop, if Start Command given again.

Please read more Description on Page. 5-49

P1-01 Master Frequency O O O X X

取值

0.00~650.00 (Hz) @ 0.00

功能

Master Frequency (Auto Process Speed 0)

P1-02 Auto Process Speed 1 O O O X X

取值

0.00~650.00 (Hz) @ 0.00

P1-03 Auto Process Speed 2 O O O X X

取值

0.00~650.00 (Hz) @ 0.00

P1-04 Auto Process Speed 3 O O O X X

取值

0.00~650.00 (Hz) @ 0.00

P1-05 Auto Process Speed 4 O O O X X

取值

0.00~650.00 (Hz) @ 0.00

P1-06 Auto Process Speed 5 O O O X X

取值

0.00~650.00 (Hz) @ 0.00

P1-07 Auto Process Speed 6 O O O X X

取值

0.00~650.00 (Hz) @ 0.00

P1-08 Auto Process Speed 7 O O O X X

取值

0.00~650.00 (Hz) @ 0.00

P1-09 Auto Process Speed 8 O O O X X

取值

0.00~650.00 (Hz) @ 0.00

P1-10 Auto Process Speed 9 O O O X X

取值

0.00~650.00 (Hz) @ 0.00

P1-11 Auto Process Speed 10 O O O X X

取值

0.00~650.00 (Hz) @ 0.00

P1-12 Auto Process Speed 11 O O O X X

取值

0.00~650.00 (Hz) @ 0.00

P1-13 Auto Process Speed 12 O O O X X

取值

0.00~650.00 (Hz) @ 0.00

P1-14 Auto Process Speed 13 O O O X X

取值

0.00~650.00 (Hz) @ 0.00

P1-15 Auto Process Speed 14 O O O X X

取值

0.00~650.00 (Hz) @ 0.00

P1-16 Auto Process Speed 15 O O O X X

取值

0.00~650.00 (Hz) @ 0.00

P1-17 Run Time 0 for Speed 0 X O O X X

取值

0.0~3600.0 (Sec.) @ 0.0

P1-18 Run Time 1 for Speed 1 X O O X X

取值

0.0~3600.0 (Sec.) @ 0.0

P1-19 Run Time 2 for Speed 2 X O O X X

取值

0.0~3600.0 (Sec.) @ 0.0

P1-20 Run Time 3 for Speed 3 X O O X X

取值

0.0~3600.0 (Sec.) @ 0.0

P1-21 Run Time 4 for Speed 4 X O O X X

取值

0.0~3600.0 (Sec.) @ 0.0

P1-22 Run Time 5 for Speed 5 X O O X X

取值

0.0~3600.0 (Sec.) @ 0.0

P1-23 Run Time 6 for Speed 6	X	O	O	X	X
取值					
0.0~3600.0 (Sec.)					@ 0.0
P1-24 Run Time 7 for Speed 7	X	O	O	X	X
取值					
0.0~3600.0 (Sec.)					@ 0.0
P1-25 Run Time 8 for Speed 8	X	O	O	X	X
取值					
0.0~3600.0 (Sec.)					@ 0.0
P1-26 Run Time 9 for Speed 9	X	O	O	X	X
取值					
0.0~3600.0 (Sec.)					@ 0.0
P1-27 Run Time 10 for Speed 10	X	O	O	X	X
取值					
0.0~3600.0 (Sec.)					@ 0.0
P1-28 Run Time 11 for Speed 11	X	O	O	X	X
取值					
0.0~3600.0 (Sec.)					@ 0.0
P1-29 Run Time 12 for Speed 12	X	O	O	X	X
取值					
0.0~3600.0 (Sec.)					@ 0.0
P1-30 Run Time 13 for Speed 13	X	O	O	X	X
取值					
0.0~3600.0 (Sec.)					@ 0.0
P1-31 Run Time 14 for Speed 14	X	O	O	X	X
取值					
0.0~3600.0 (Sec.)					@ 0.0
P1-32 Run Time 15 for Speed 15	X	O	O	X	X
取值					
0.0~3600.0 (Sec.)					@ 0.0
P1-33 Run Direction 0 for Speed 0	X	O	O	X	X
取值					
STOP					@ [0]
FWD					[1]
REV					[2]
P1-34 Run Direction 1 for Speed 1	X	O	O	X	X
取值					
STOP					@ [0]
FWD					[1]
REV					[2]
P1-35 Run Direction 2 for Speed 2	X	O	O	X	X
取值					
STOP					@ [0]
FWD					[1]
REV					[2]

	Run	Mod	Initial	V/F	o2-4
P1-36 Run Direction 3 for Speed 3	X	O	O	X	X
取值					
STOP					@ [0]
FWD					[1]
REV					[2]
P1-37 Run Direction 4 for Speed 4	X	O	O	X	X
取值					
STOP					@ [0]
FWD					[1]
REV					[2]
P1-38 Run Direction 5 for Speed 5	X	O	O	X	X
取值					
STOP					@ [0]
FWD					[1]
REV					[2]
P1-39 Run Direction 6 for Speed 6	X	O	O	X	X
取值					
STOP					@ [0]
FWD					[1]
REV					[2]
P1-40 Run Direction 7 for Speed 7	X	O	O	X	X
取值					
STOP					@ [0]
FWD					[1]
REV					[2]
P1-41 Run Direction 8 for Speed 8	X	O	O	X	X
取值					
STOP					@ [0]
FWD					[1]
REV					[2]
P1-42 Run Direction 9 for Speed 9	X	O	O	X	X
取值					
STOP					@ [0]
FWD					[1]
REV					[2]
P1-43 Run Direction 10 for Speed 10	X	O	O	X	X
取值					
STOP					@ [0]
FWD					[1]
REV					[2]
P1-44 Run Direction 11 for Speed 11	X	O	O	X	X
取值					
STOP					@ [0]
FWD					[1]
REV					[2]
P1-45 Run Direction 12 for Speed 12	X	O	O	X	X
取值					
STOP					@ [0]
FWD					[1]
REV					[2]

P1-46 Run Direction 13 for Speed 13		X	O	O	X	X
取值						
STOP					@	[0]
FWD						[1]
REV						[2]

P1-48 Run Direction 15 for Speed 15		X	O	O	X	X
取值						
STOP					@	[0]
FWD						[1]
REV						[2]

P1-47 Run Direction 14 for Speed 14		X	O	O	X	X
取值						
STOP					@	[0]
FWD						[1]
REV						[2]

● Enable the Auto Process Operation

This Function is used in Conjunction with a Multi-function Contact Input set for Auto Process Operation (H1-__ = "86") and activates this Input Terminal. The related Parameters and Setting are shown as below.

1. Set Auto Process Operation Mode Selection (P1-00) to 1~4
2. Set Process Frequency Reference 0~15 (P1-01~P1-16), Running Time for each Reference (P1-17~P1-32) and Running Direction for Each Reference, that could be Simple Process Control.

● Auto Process Operation Mode Selection (P1-00) Selection Description.

(A) Executes 1 Cycle Operation then Stop (P1-00= 1 or 4)

VFD is according to set Operation mode, Operates One Cycle then Stop, LCP shows "STP0".

i.e. P1-01= 1 or 4, Frequency: P1-01= 15Hz P1-02= 30Hz P1-03= 50Hz P1-04= 20Hz
 Run Time: P1-17= 20Sec. P1-18= 25Sec. P1-19= 30Sec. P1-20= 40Sec.
 Direction: P1-33= FWD P1-34= FWD P1-35= FWD P1-36= REV
 Else: P1-05~P1-16= 0Hz, P1-21~P1-32= 0Sec. P1-37~P1-48= 0 (Stop)

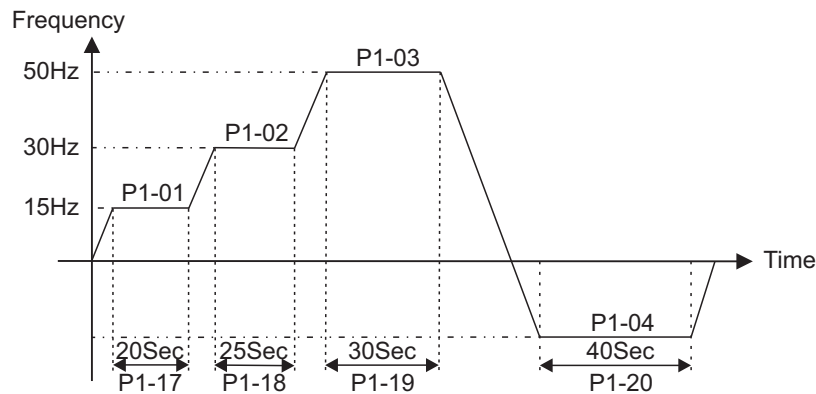

Fig. Executes 1 Cycle Operation then Stop (P1-00= 1 or 4)

(B) Continuously Executes Cycles Operation (P1-00= 2 or 5)

VFD is according to set Operation mode, Operates One Cycle then Repeats.

i.e. P1-01= 2 or 5, Else Setting as (A)

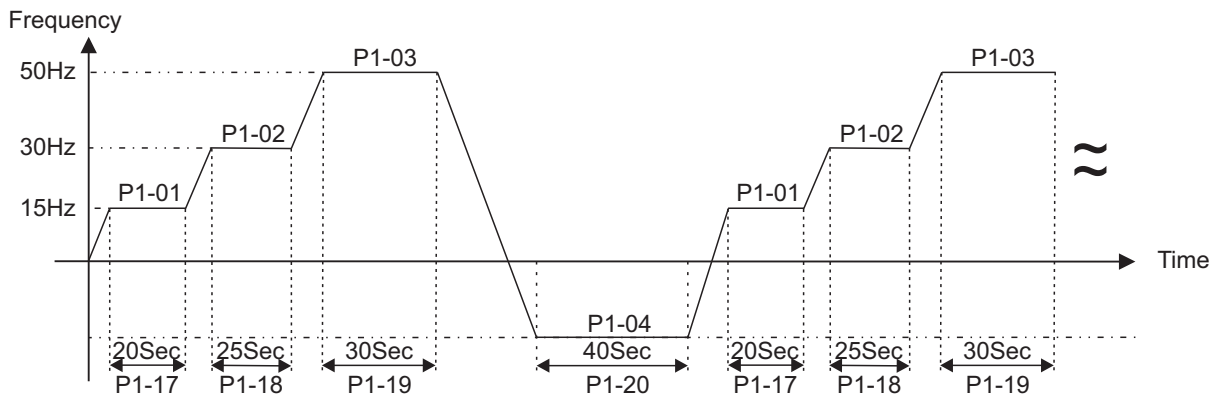

Fig. Continuously Executes Cycles Operation (P1-00= 2 or 5)

- (C) Executes 1 Cycle Operation then Keep Running at Last Process Speed (P1-00= 3 or 6)
 VFD is according to set Operation mode, Operates One Cycle then Keep Running at Last Process Speed "Auto Process Speed 15" (P1-16), In other words it is needed to set the P1-16 and closely associated Parameters when P1-00=3 or 6.
 i.e. P1-01= 3 or 6, Else Setting as (A)

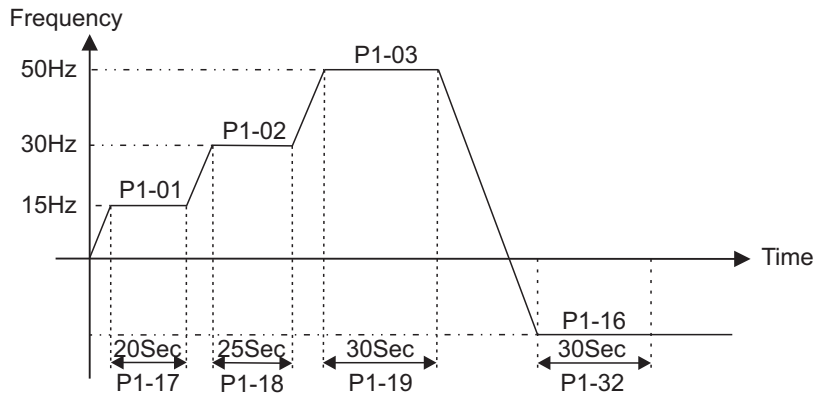

Fig. Executes 1 Cycle Operation then Keep Running at Last Process Speed (P1-00= 3 or 6)

- Note:**
- If P1-00= 1~3, VFD Restarts after Stop Command has given (Discontinue the Operation), it should accord to the Set P1-00 then starts from the Last Speed before VFD Stops.
 - If P1-00= 4~6, VFD Restarts after Stop Command has given (Discontinue the Operation), it should accord to the Set P1-00 then starts from the Original Master Frequency Reference (Auto Precess Speed 0).

P1-00=	1, 2, 3	4, 5, 6
Run Command		
Output Frequency		
Time		

• Auto Process Operation Setting for Different Run Command Source

Please refer to Page. 5-44 "Enable the Auto Process Operation" then see. the Examples below.

- Run/ Stop Source from LCP (B1-02= 0)
 - i.e. (1) H1-02= 86 (Terminal D2)
 - (2) Accords to previous "P1-00 Selection Description" for P1-00 Set.
 - (3) Activates Terminal D2 let VFD into Auto Process Mode, then Uses RUN/ STOP Keys to Run or Stop the VFD with Auto Process Operation.
- Run/ Stop Source from Terminals (B1-02= 1)
 - i.e. (1) B1-11= 0 (Terminal Control Mode is FWD/STOP or REV/STOP), Set B1-11=1 or 2 is Prohibited.
 - (2) H1-01= 80 (Terminal D1 for FWD/STOP Control), H1-02= 86 (Terminal D2)
 - (3) Accords to previous "P1-00 Selection Description" for P1-00 Set
 - (4) Activates Terminal D2 let VFD into Auto Process Mode, then Uses Terminal D1 Signal to Run/ Stop the VFD with Auto Process Operation.
- Run/ Stop Source from Serial Communication (B1-02= 2)
 - i.e. (1) H1-02= 86 (Terminal D2)
 - (3) Accords to previous "P1-00 Selection Description" for P1-00 Set
 - (4) Use Serial Communication Command to activate the Dummy Terminal D2 let VFD into Auto Process Mode, then Uses Serial Communication to Run/ Stop the VFD with the Auto Process Operation.

5.11 VVT Adjusting, Group (T)

Parameters in Group (T) are Related with the Processor Programming of VFD, the VFD will Regulate the Output Automatically according to Parameter Set Group (T) and Feedback Detection.

Please adjust the following Parameters based on Motor Specification and Application if Needed.

5.11.1 Motor Nameplate Data: T1

T1-01 Motor Autotuning X O O X O

取值

Autotuning deactivate @ [0]
Autotuning activate [1]

T1-02 Motor Rated Power (kW) X O O X O

取值

VFD Model Dependent

T1-03 Motor Rated Voltage (VAC) X O O X O

取值

VFD Model Dependent

T1-04 Motor Rated Current (A) X O O X O

取值

VFD Model Dependent

T1-05 Motor Rated Frequency (Hz) X O O X O

取值

VFD Model Dependent

T1-07 Motor Rated Speed (RPM) X O O X O

取值

VFD Model Dependent

Autotuning Tips:

1. Input the related Motor Data to Parameters T1-02~ T1-07 accords to Motor Nameplate.
2. Start the Autotuning by Set T1-01 to 1 after Step1 was done, then LCP will show "-AT-" during Autotuning Process.
3. LCP returns to T1-01 once Autotuning success after "End" is shown.
4. The result of Autotuning will be saved in Parameter Group T2.

5.11.2 Motor Autotuned Constants: T2

T2-00 VVT Torque Compensation K O O X X O

取值

0~600 @ Autotuned
Dependent

功能

Torque Compensation Coefficient for VVT Control

功能说明

Increases the T2-00 to Enlarge Output Torque for the Load is too Heavy if need.

$$\Delta T_e = \underset{\text{(Load Current)}}{I} \times \underset{\text{(T2-00)}}{\text{Coefficient}}$$

Note:

- Frequency Range of Torque Compensation: 0~ Motor Rated Frequency
- If Motor Output Torque is Insufficient to the Load, then Enlarges T2-00.
- When the Load is under Hunting or Vibration Situation, then Reduces T2-00.
- The Maximum Output Torque is Limited by VFD Rated Current.
- If the Current Rise when T2-00 is Enlarged, please Enlarges the Slip Compensation Coefficient (T2-01) at the Same Time.

T2-01 VVT Slip Compensation K O O X X O

取值

0~600 @ Autotuned
Dependent

功能

Slip Compensation Coefficient for VVT Control

功能说明

Increases the T2-01 to Enlarge Slip Frequency for the Load if too Heavy if need:

• Torque/ Speed Pattern Characteristic is as Below:

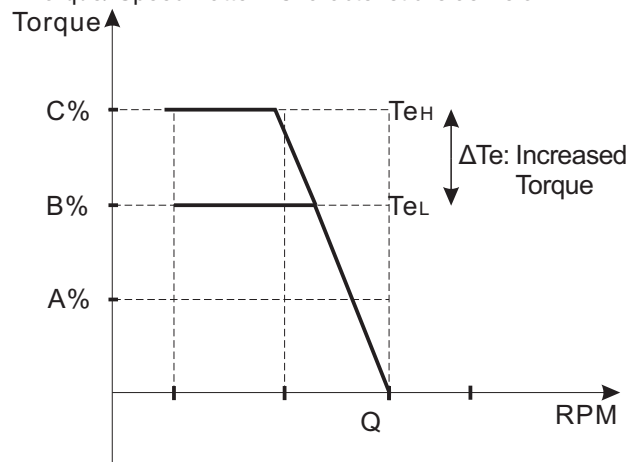

$$\Delta F_{\text{slip}} = \underset{\text{(Load Current)}}{I} \times \underset{\text{(T2-01)}}{\text{Coefficient}}$$

- Torque/ Speed Pattern Characteristic is as Below:

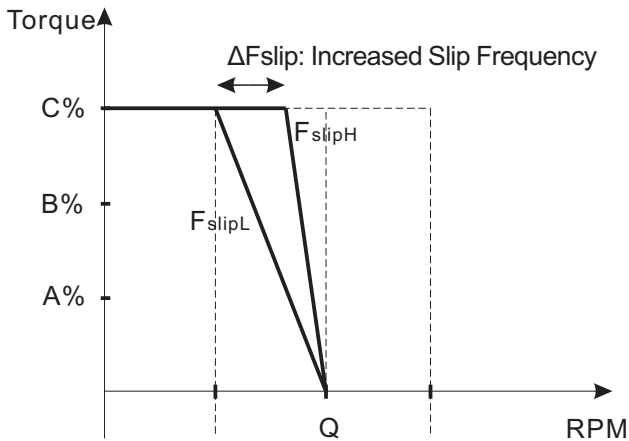

Note:

- Frequency Range of Torque Compensation: 0~ Motor Rated Frequency
- If Motor Speed is Insufficient to the Load, then Enlarges T2-01.
- When the Load is under Hunting or Vibration Situation, then Reduces T2-01.
- The Maximum Output Frequency is Limited by set T1-05 Motor Rated Frequency.
- If the Current Rise when T2-01 is Enlarged, please Enlarges the Torque Compensation Coefficient (T2-00) at the Same Time.

T2-02 Equivalent Inductance Gain

取值

----- @ Autotuned
Dependent

功能

Autotuned Equivalent Inductance Gain

T2-03 Magnetized Current Gain

取值

----- @ Autotuned
Dependent

功能

Autotuned Magnetized Current Gain

T2-04 Ferrite Loss Conductance

取值

----- @ Autotuned
Dependent

功能

Autotuned Ferrite Loss Conductance

Run | Mod | Initial | V/F | o2-4

T2-05 VVT Torque Boost at Low Speed

取值

0~300 (%) @ 90

功能

Torque Compensation Gain @ Low Speed for VVT CTL

功能说明

Increases the T2-05 to Enlarge the Output Voltage. In the meanwhile, the Output Toque of Low Frequency will be Enlarged too.

- Output Voltage/ Output Frequency Pattern Characteristic is as Below:

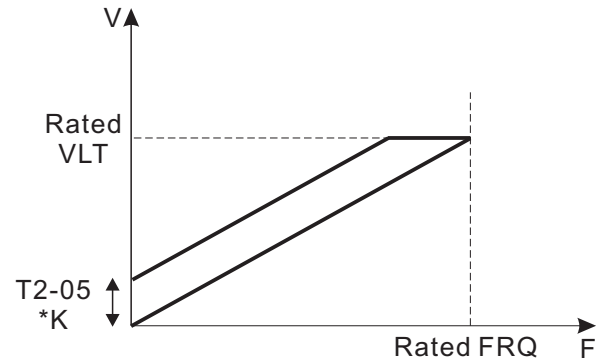

$$K \approx SWF \times U1-07 / 60000$$

Note:

- Frequency Range of Torque Compensation:
0~ 12Hz @ 60Hz Rating
0~ 10Hz @ 50Hz Rating
- Whe in Motor Low Frequency: Torque is Insufficient to the Load, then Enlarges T2-05. The Load is in Vibration Situation, then Reduces T2-05.

6. Fault Code and Troubleshooting

6.1 Warning/ Fault Condition, the Possible Causes of Problem

6.1.1 VFD Faults & Remedy

When the YD101 Detects a Fault, the Fault Message is displayed on the LCP and Activates a Fault Signal Output, after which the Motor Coasts to a Stop (Some Stopping Method of the Fault is Selectable, the VFD should follow the Set way to Stop when the Fault Occurs).

To Restart the VFD, please follow the Remedial Actions Below.

- Remove Any Run Command.
- Refer to the Following **Table. Fault Conditions, the Possible Causes and Remedial Actions (cotinued)**.
- Turn ON the Reset Input Signal or Depress the RESET Key on the LCP, or Cycle Power to Reset the Stop Status.
- Remedial Actions Described does not solve the Problem, please contact Yolico Representative for Help.

Table. Fault Conditions, the Possible Causes and Remedial Actions

Fault Condition	Name & Possible Causes	Remedy	Reset (*)
OC Overcurrent	VFD Over Current Motor Current Exceeds the Peak VFD Current (Approximately 200% VFD Rated Current): <ul style="list-style-type: none"> • Too High Motor Load, Too Short Acceleration Time. • Excessive Load Change • Soft Short-circuit between Phases or Phase to Earth • Poor or Loose Motor Cable Connections 	<ul style="list-style-type: none"> • Check on Acceleration Time settings and make them Longer if Necessary. • Check on Motor Load. • Check Motor Coil Resistance & Insulation • Check on Bad Motor Cable Connections • Check on Bad Earth Cable Connection • Check on Water or Moisture in the Motor Housing and Cable Connections. 	B
SC Shortcircuit	Short Circuit <ul style="list-style-type: none"> • VFD Output (Load) is Short Circuited. 	<ul style="list-style-type: none"> • Check Motor Coil Resistance & Insulation • Check on Motor Installation. • Check on Bad Motor Cable Connections 	B
OV Overvoltage	DC Bus Over Voltage Too High DC Link Voltage Exceeded the Over Voltage Detection Level during Running. 200V Class: Approx. 410V, 400V Class: Approx. 820V <ul style="list-style-type: none"> • Too Short Deceleration Time with Respect to Motor/ Machine Inertia. • Too Small Braking Resistor, or Malfunctioning Brake Transistor or Unit. • Power Supply Voltage is too High 	<ul style="list-style-type: none"> • Check on Deceleration Time Settings and make them Longer (if necessary). • Add a Suitable Size Braking Circuit (if Necessary). • Check on Size of the Brake Circuit and the Related Parameter Setting (if Used) • Check and Decease the Power Supply Voltage within VFD Specification 	B
Uv1 Undervoltage	DC Bus Under Voltage Too Low DC Link Voltage Exceeded the Under Voltage Detection Level during Running. 200V Class: Approx. 190VDC or less, 400V Class: Approx. 380VDC or less. <ul style="list-style-type: none"> • Too Low or No Supply Voltage or Phase Loss • Mains Voltage Dip due to Starting Other Major Power Consuming Machines on the Same Line. • Poor or Loose Mains Cable Connections. 	<ul style="list-style-type: none"> • Make sure all Single/ Three Phases are Properly Connected and that the Terminal Screws are Tightened. • Check that the Mains Supply Voltage is within the Limits of the VFD. • Try to use Other Mains Supply Lines if Dip is caused by Other Machinery • Use the Momentary Power Loss Function 	B
Uv3 Undervoltage	MC Answer Back Inrush Prevention Circuit or MC (Relay) Fault <ul style="list-style-type: none"> • The Pre-charge Relay (Contactor) Opened during Running. 	<ul style="list-style-type: none"> • Check that the Mains Supply Voltage and Wiring. • Check on Pre-charge Circuit 	N

Note:

- A: Fault can be Reset by Auto Restart Function.
- M: Fault can be Reset by Manual Input (Reset Key of LCP or Multi-function Contact Input)
- B: Fault can be Reset by Auto Restart Function/ Manual
- N: Fault can not be Reset

Table. Fault Conditions, the Possible Causes and Remedial Actions- continued

Fault Condition	Name & Possible Causes	Remedy	Reset (*)
OH Overtemp	<p>Heat Fins Over Temperature The Heat Fins Temperature too High, over than Hardware Protection Level.</p> <ul style="list-style-type: none"> • Too High Ambient Temperature • Heat Source Nearby or Insufficient Cooling • Blocked or Stuffed Cooling Fan 	<ul style="list-style-type: none"> • Check on Cooling of the VFD Cabinet. • Install a Cooling Unit or Remove Heat Source • Check on Functionality of the Built-in Cooling Fans by L8-04 Setting. • Replace a New Fan (if Necessary). • Clean Fans 	B
OL1 Overload	<p>Motor Over Loaded VFD Output Exceeded the Motor Overload Level.</p> <ul style="list-style-type: none"> • Load too Heavy • Acceleration, Deceleration, Cycle are too Short. • V/F Curve Voltage too High • E2-01 Setting Value is Wrong(too Small) • Self-Cooled Motor at Low Speed, High Load 	<ul style="list-style-type: none"> • Check on Mechanical Overload on Motor or the Machinery (Bearing, Gearbox, Chains, Belts, etc.) • Reduce the Load. • Check on Acceleration, Deceleration, Cycle Time. • Check on V/F Curve Setting. • Check on E2-01 Motor Rating Current Setting • Check on L1-07/ 08 and Motor Cooling System 	M
OL2 Overload	<p>VSD output exceeded the VFD Overload Level.</p> <ul style="list-style-type: none"> • Load too Heavy • Acceleration, Deceleration, Cycle are too Short. • V/F Curve Voltage too High • The VFD Size too Small 	<ul style="list-style-type: none"> • Check on Mechanical Overload on Motor or the Machinery (Bearing, Gearbox, Chains, Belts, etc.) • Reduce the Load. • Check on Acceleration, Deceleration, Cycle Time. • Check on V/F Curve Setting. • Replace VFD by Bigger Size 	M
CPF03 EEPROM	<p>EEPROM Error</p> <ul style="list-style-type: none"> • VFD's PCB Control Board Fault. 	<ul style="list-style-type: none"> • Turn Power Supply Off and On again • VFD needs to Repair (if Failure still On after Cycled Power) 	N
CTER CT Error	<p>Current Transducer Error</p> <ul style="list-style-type: none"> • VFD's Hardware Fault. 	<ul style="list-style-type: none"> • VFD needs to Repair. 	N

Note:

M: Fault can be Reset by Manual Input (Reset Key of LCP or Multi-function Contact Input)

B: Fault can be Reset by Auto Restart Function/ Manual

N: Fault can not be Reset

6.1.2 VFD Warnings & Remedy

Unlike Faults, Warnings do not activate Fault Contact Outputs, and The Warning Signal can not be Reset by Auto Restart Function or Manual. After the Cause of the Warning is corrected, the VFD Returns to its Former Operation Status Automatically.

The Digital Operator may display in Blinking when a Warning Occurs. please follow the **Table. Warning Conditions, the Possible Causes and Remedial Actions** for more Detail & Remedial Actions Below.

Table. Warning Conditions, the Possible Causes and Remedial Actions

Warning Condition	Name & Possible Causes	Remedy
Uv (Blinking) Undervoltage	DC Bus Under Voltage Too Low DC Link Voltage Exceeded the Under Voltage Detection Level during in Ready. 200V Class: Approx. 190V or less, 400V Class: Approx. 380V or less. <ul style="list-style-type: none"> ● Too Low or No Supply Voltage or Phase Loss ● Mains Voltage Dip due to Starting Other Major Power Consuming Machines on the Same Line. ● Poor or Loose Mains Cable Connections. ● The Pre-charge Relay (Contactor) Opened. 	<ul style="list-style-type: none"> ● Make sure all Single/ Three Phases are Properly Connected and that the Terminal Screws are Tightened. ● Check that the Mains Supply Voltage is within the Limits of the VFD. ● Try to use Other Mains Supply Lines if Dip is caused by Other Machinery ● Use the Momentary Power Loss Function ● Check on Pre-charge Circuit
OV (Blinking) Overvoltage	DC Bus Over Voltage Too High DC Link Voltage Exceeded the Over Voltage Detection Level during in Ready. 200V Class: Approx. 410V, 400V Class: Approx. 820V <ul style="list-style-type: none"> ● Power Supply Voltage is too High 	<ul style="list-style-type: none"> ● Check and Decrease the Power Supply Voltage within VFD Specification
OH (Blinking) Overtemp	Heat Fins Over Temperature The Heat Fins Temperature too High, over than Hardware Protection Level during in Ready. <ul style="list-style-type: none"> ● Too High Ambient Temperature ● Heat Source Nearby or Insufficient Cooling ● Blocked or Stuffed Cooling Fan 	<ul style="list-style-type: none"> ● Check on Cooling of the VFD Cabinet. ● Install a Cooling Unit or Remove Heat Source ● Check on Functionality of the Built-in Cooling Fans by L8-04 Setting. ● Replace a New Fan (if Necessary). ● Clean Fans

6.1.3 VFD Special Conditions & Remedy

Like Warnings, the Fault Contact Outputs will not activate, and the Conditions can not be Reset neither. After the Cause of the Condition is corrected, the VFD Returns to its Former Operation Status Automatically.

The Digital Operator may display in Blinking when a Special Condition Occurs. please follow the **Table. Special Conditions, the Possible Causes and Remedial Actions** for more Detail & Remedial Actions Below.

Table. Special Conditions, the Possible Causes and Remedial Actions

Special Condition	Name & Possible Causes	Remedy
CE (Blinking) Modbus Error	MODBUS Communication Discontinue Communication Lost Time is longer than MODBUS Time Out Detection Value (H5-11).	<ul style="list-style-type: none"> • Check Communication Devices and Transmission Signals. • Check On Set Value of H5-11.
STP0	VFD during in Zero Speed Run Command is activated (On) and Frequency Reference is < 0.1Hz.	<ul style="list-style-type: none"> • Stop VFD • Set Frequency Reference > 0.1Hz
STP1 (Blinking)	Direct Start after Power Up Fail VFD's Run Command Source set from Terminal (B1-02= 1) and Direct Start after Power Up Selection (L5-06= 1), the Run Signal is activated before Mains is Powered.	<ul style="list-style-type: none"> • Check On the Functionality of the L5-06 • Cycle the Run Signal to Run VFD.
STP2 (Blinking)	STOP Key of LCP is Depressed When the Run Command is not through LCP and LCP Stop Key Selection is set to Enable (O2-02= 0), once the STOP Key is Depress during VFD in Running, the VFD Stops according B1-03 selected way, a Blinking "STP2" is displayed on LCP.	<p>To Restart VFD, please refer the way below:</p> <ul style="list-style-type: none"> • Run Command by Terminals (B1-02= 1): Cycle the Run Signal, VFD Starts again. • Run Command by Serial Communication (B1-02= 2): The Master (Controller) Transmits a "STOP" Signal then "RUN" Signal, VFD Starts again. • Check On the Functionality of the L5-06
E.S. (Blinking)	External Fast Stop Signal is Input An Fast Stop Signal is active by Input Terminal D1 to D6 <ul style="list-style-type: none"> • H1-01 to H1-06 is set to 15 • Terminal D1~D6 s Enabled during Related Situation 	<ul style="list-style-type: none"> • Check On the Terminals Status. • Check On Functionality and Setting of Terminal D1~D6 (Parameter H1-01~ H1-06 and H1-11, H1-12 (If Necessary)
b.b.. (Blinking)	External Base Block Signal is Input An Base-block Signal is active by Input Terminal D1 to D6 <ul style="list-style-type: none"> • H1-01 to H1-06 is set to 82 • Terminal D1~D6 is Enabled during Related Situation 	<ul style="list-style-type: none"> • Check On the Terminals Status. • Check On Functionality and Setting of Terminal D1~D6 (Parameter H1-01~ H1-06 and H1-11, H1-12 (If Necessary)

6.1.4 VFD Operation Error & Remedy

Setting the Parameters, if the set Value is Out of the Valid Range or the Functionality between Parameters are contradictory, the Operation Error Code will Appear on LCP. An Operation Error do not activate Fault Contact Outputs, and the VFD can not Start and Warning Signal can not be Reset neither.

Please refer to **Table. Operation Error Conditions, the Possible Causes and Remedial Actions** below to correct the Cause of the Error.

Table. Operation Error Conditions, the Possible Causes and Remedial Actions

Error Condition	Name & Possible Causes	Remedy
OPE01	VFD Capacity Setting is incorrect <ul style="list-style-type: none"> ● o2-04 doesn't match with VFD Hardware Detection 	<ul style="list-style-type: none"> ● Contact Yolico Representative to get the Support
OPE02 Limit	Parameter Setting Range is Incorrect <ul style="list-style-type: none"> ● The Parameter Setting Value is Out of the Valid Range. 	<ul style="list-style-type: none"> ● Check the Setting Value
OPE12 Limit	Operation Incorrect <ul style="list-style-type: none"> ● Depress the Increasing or Decreasing Key when B1-01 > 0 or Preset Speed Operation. ● Try to change Parameter that is not allowed to change during VFD in Runing. 	<ul style="list-style-type: none"> ● Check B1-01 Setting Value. ● Change Parameter when VFD in Stop.
OPE13 Comm Error	Communication Write Error <ul style="list-style-type: none"> ● Try to change Parameters that is not allowed to be changed by Communication 	<ul style="list-style-type: none"> ● Do the Correct Parameter Setting before communicate to VFD.
OPE14 Comm Fault	MEMOBUS Transmission Error <ul style="list-style-type: none"> ● Transmission Command is Incorrect. ● Communication Parameters Setting is Incorrect ● Check-Sum Error 	<ul style="list-style-type: none"> ● Check the Transmission Command for Master (Controller) ● Communication Parameters Setting H5-01~ H5-12
OPE15 Comm Fault	Parameter Setting Error <ul style="list-style-type: none"> ● Try Change O2-04 ● Try to change Parameters Value that is Out of Valid Range by Communication. 	<ul style="list-style-type: none"> ● Set Parameters Value in Valid Range
LOC	Password is Incorrect or Setting Prohibited <ul style="list-style-type: none"> ● Try to change Parameter while Password Protection in Lock-Out ● The Parameter is not allowed to change. 	<ul style="list-style-type: none"> ● Keyin Correct Password ● Try another Parameter or Control Status

7. Maintenance and Inspection

7.1 Maintenance and Inspection

This Section describes Basic Maintenance and Inspection Procedures for the YD101 Series VFD, Yolico offers the Warranty to Ensure Quality of YD101.

The YD101 will Function Longer if it is kept Clean, Cool and Dry, and if all Precautions Highlighted in this Manual are Observed. Make a Visually Inspect and Routine Maintenance for the VFD as Described in the Table below to Prevent Accidents and to Ensure High Performance with High Reliability.

To Prevent Electrical Shock, Disconnect all Power before Servicing the VFD. Then wait at Least Five Minutes (10 Minutes for 15kW and Above Sizes) after the Power Supply is Disconnected and all LEDs are Extinguished.

■ Routine Inspection

Follows Item below check the System in Operation Daily.

- The Motor should not be Vibrating or Making Unusual Noises.
- There should be no Abnormal Heat Generation.
- The Ambient Temperature should not be Too High.
- The Output Current Value shown on the LCP should not be Higher than Normal.
- The Cooling Fan on the Bottom of the VFD should be Operating Normally.

■ Periodic Inspection & Maintenance

Table Periodic Inspections & Maintenance

Items	Inspection	Remedial Actions
External Device, Terminals, Mounting Bolts, Connectors, etc...	Are all Screws and Bolts Tight?	Tighten Loose Screws and Bolts Firmly.
	Are Connectors Tight?	Reconnect the Loose Connectors.
Heat Fins	Are the Fins Dirty or Dusty?	Clean Off Any Dirt and Dust with an Air Gun using Dry Compressed Air. (*)
PCBs (If Possible)	Is there Any Conductive Dirt or Oil Mist on the PCBs?	Clean Off Any Dirt and Dust with an Air Gun using Dry Compressed Air. (*) Replace the Boards if they can not be made Clean.
Cooling Fan	Is there Any Abnormal Noise or Vibration or has the Total Operating Time Exceeded 20,000 Hours?	Replace the Cooling Fan.
Power Elements	Is there any Conductive Dirt or Oil Mist on the Elements?	Clean Off Any Dirt and Dust with an Air Gun using Dry Compressed Air. (*)
Smoothing Capacitor	Are there any Irregularities, such as Discoloration or Odor?	Replace the Capacitor or VFD.

Note: The Compressed Dry Air is Recommended at a Pressure of 39.2×10^4 to 58.8×10^4 Pa (4 to 6 kg-cm²).

■ Periodic Maintenance of Parts

The VFD is configured by Many Parts, and these Parts Operate properly to make Full use of the VFD Functions.

Among the Electronic Components, Some Parts Require Maintenance depending on the Usage Conditions. In Order to keep the VFD Operating Normally Over a Long Period of Time, it is Necessary to perform Period Inspections and Replace Parts according to their Service Life.

Periodic Maintenance and Inspection Standards vary depending the VFD's Installation Surrounding and Usage Conditions.

The VFD's Maintenance Periods are Noted below. Keep them as Reference.

Table Parts Replacement Guidelines

Parts	Standard Period	Replacement Method
Cooling Fan	2~3 Years	Replace with New Part.
Smoothing Capacitor	5 Years	Replace with New Part. (Determine need by inspection.)
MC or Relays	5 Years	Determine need by inspection.
Aluminum Capacitors on PCBs	5 Years	Replace with new board. (Determine need by inspection.)

Note: Usage Conditions are as Follows:

- Ambient Temperature: Yearly Average of 30°C
- Load Factor: 80% Max.

A. Appendix

A.1 Dynamic Braking Configuration

Depends On VFD Model and Size, YD201 Series offer Different Types of Braking Configuration for Brake Devices Connection, as Braking Resister and Braking Unit plus Resister. Please see Table A-1 below for Detail.

Table A-1 Brake Configuration Corresponds to & YD201 Size

1Ø 200V				
Model	Braking Resister Specification		Brake Current (A)	Brake Torque (%)
	Resistance (Ω)	Power(kW)		
YD201-00P4-T2S	360	0.08	1.1	120
YD201-00P7-T2S	200	0.14	2.0	116
YD201-01P5-T2S	100	0.3	3.9	116
YD201-02P2-T2S	70	0.42	5.6	114
YD201-03P7-T2	40	0.72	9.8	118

3Ø 400V				
Model	Braking Resister Specification		Brake Current (A)	Brake Torque (%)
	Resistance(Ω)	Power(kW)		
YD201-00P7-T4	750	0.2	1	123
YD201-01P5-T4	400	0.3	2	116
YD201-02P2-T4	250	0.5	3	125
YD201-0003-T4	200	0.6	4	116
YD201-0004-T4	150	0.8	5	116
YD201-05P5-T4	100	1.2	8	125
YD201-07P5-T4	75	1.6	10	123
YD201-0011-T4	50	2.4	15	125
YD201-0015-T4	40	3	19	120
YD201-18P5-T4	30	4	25	120
YD201-0022-T4	26	4	29	120
YD201-0030-T4	26	6	29	120
YD201-0037-T4	20	7	38	120
YD201-0045-T4	15	9	51	120
YD201-0055-T4	13	11	58	120
YD201-0075-T4	10	15	76	120
YD201-0093-T4	6	19	127	120
YD201-0110-T4	6	22	127	120
YD201-0132-T4	5	26	152	120
YD201-0160-T4	4	32	190	120
YD201-0185-T4	3	37	253	120
YD201-0200-T4	3	40	253	120
YD201-0220-T4	3	44	253	120
YD201-0250-T4	3	50	253	120
YD201-0285-T4	3	56	253	120
YD201-0315-T4	3	63	253	120
YD201-0355-T4	2	63	380	120

- Note:**
- The Listed Ω Value is the Specified Minimum Resister Value, if Value of Actual used Brake Resister is Smaller than the Listed Ω Value, the High Brake Current may result VFD Damaged.
 - The W is Power Rating in Watt at Specified ED%, please choose a Suitable ED% depends on the Application. Such as the Brake Duty is Less than 5 Times/ Per Minute or just Brakes in a short Time, that can use Resister in Watt @10%ED or Smaller Watt Value. If the Brake Duty is Larger than 5 Times/ Per Minute or Continue Brakes Over than 4 Minutes, that might use Resister in Watt @ 20%ED or Larger Watt Value, i.e. the Cycling Textile Machine.

● Calculation for Brake Resister Watt Rating

For 400V Class $W = \frac{577600}{\text{Resister Ohm Value}} \times \text{ED}\%$

For 200V Class $W = \frac{144400}{\text{Resister Ohm Value}} \times \text{ED}\%$

		ED%
General Load	5 Times less/ per Minute or 20Sec. less/ per Brake	10%
	20Sec. ~4 Minutes / per Brake	15%
High Brake Freq. or Long Time Brake	More than 5 Times/ per Sec. or more than 4 Minutes/ per Brake	20%

A.2 Parameter List Table

Function	Parameter No.	Name & (Digital Operator Displayed)	Default	Setting Range	Minimum Unit	User Setting		
U (Monitor)	U1-(Situation Monitor)	U1-01	Frequency Reference	0.01Hz		
		U1-02	Output Frequency	0.01Hz		
		U1-03	Output Current	0.1A		
		U1-06	Output Voltage	0.1V		
		U1-07	DC Bus Voltage	1V		
		U1-10	Input Terminal Status		
		U1-11	Output Terminal Status		
		U1-14	Software Number		
		U1-15	Frequency Reference Terminal AVI Input Level	0.1%		
		U1-16	CTL Terminal ACI Input Level	0.1%		
		U1-24	PID Feedback Capacity	0.1%		
		U1-46	IGBT Temperature		
		U1-47	Counter Present Value		
		U1-48	Worked Time 1	1Hour		
		U1-49	Worked Time 2	1Day		
		U3-(Fault Log)	U3-	U3-01	Most Recent Fault
U3-02	2nd Most Recent Fault				
U3-03	3rd Most Recent Fault				
A (Environment)	A1-(Environment)	A1-02	CTL Method Selection	0	0 / 5		
		A1-03	Initialize Parameters	0	0 ~ 65535		
		A1-04	Password	0	0 ~ 65535		
B (Application)	B1-(Sequence)	B1-01	Reference Source	0	0 ~ 2, 4 ~ 6		
		B1-02	Run Command Source	0	0 ~ 2		
		B1-03	Stopping Method Selection	0	0 ~ 1		
		B1-04	Reverse Operation Prohibit	0	0 ~ 1		
		B1-06	Digital Input Scan Time	5	1 ~ 100	1		
		B1-09	Auxiliary Run Source Selection	0	0 ~ 2		
		B1-10	Auxi. Reference Source Selection	0	0 ~ 2, 4 ~ 6		
		B1-11	Multi-function Input Terminals CTL Method Selection	0	0 ~ 2		
	B2-(DC Brake)	B2-	B2-01	DC Braking Frequency at Stop	1.5	0.10 ~ 10.00	0.01Hz	
			B2-02	DC Braking Current at Stop	50.0	0.0 ~ 150.0	0.1%	
			B2-03	DC Braking Time at Start	0.0	0.0 ~ 25.5	0.1Sec.	
			B2-04	DC Braking Time at Stop	0.5	0.0 ~ 25.5	0.1Sec.	
			B2-09	DC Braking Current at Start	0.0	0.0 ~ 150.0	0.1%	
	B3-(Speed Search)	B3-	B3-01	Speed Search at Start	0	0 ~ 1	
			B3-04	Speed Search Method	0	0 ~ 1	
			B3-05	Speed Search Error Constant	250	1 ~ 8192	1	
	B5-(PID CTL)	B5-	B5-01	PID CTL Mode Selection	0	0 ~ 4	
			B5-02	PID Feedback Regulated Gain	1.00	0.00 ~ 10.00	0.01	
			B5-03	PID CTL Proportional Gain	1.0	0.0 ~ 10.0	
			B5-04	PID CTL Integral Time	10.0	0.0 ~ 100.0	0.1Sec.	
B5-05			PID CTL Derivative Time	0.00	0.00 ~ 10.00	0.01Sec.		

Function	Parameter No.	Name & (Digital Operator Displayed)	Default	Setting Range	Minimum Unit	User Setting	
B (Application)	B5-(PID CTL)	B5-06	PID CTL Offset +/- Selection	0	0 ~ 1	
		B5-07	PID CTL Offset	0	0 ~ 109	1%	
		B5-08	PID Output Primary Delay Time	0.0	0.0 ~ 2.5	0.1Sec.	
		B5-09	PID Feedback Loss Action	0	0 ~ 2	
		B5-10	PID Feedback Loss Decion Level	0	0 ~ 100	1%	
		B5-11	PID Feedback Loss Detection Time	1.0	0.0 ~ 25.5	0.1Sec.	
		B5-12	PID CTL Integral Limit	100	0 ~ 109	
		B5-14	PID Sleep Frequency	0.00	0.00 ~ 650.00	0.01Hz	
		B5-15	PID Sleep Delay Time	0.0	0.0 ~ 25.5	0.1Sec.	
		B5-16	PID Wake Up Frequency	0.00	0.00 ~ 650.00	0.01Hz	
		B5-17	PID Wake Up Delay Time	0.0	0.0 ~ 25.5	0.1Sec.	
C (Tuning)	C1- (ACC/ DEC Time)	C1-01	Acceleration Time 1	10.0	0.1 ~ 3600.0	0.1Sec.	
		C1-02	Deceleration Time 1	10.0	0.1 ~ 3600.0	0.1Sec.	
		C1-03	Acceleration Time 2	10.0	0.1 ~ 3600.0	0.1Sec.	
		C1-04	Deceleration Time 2	10.0	0.1 ~ 3600.0	0.1Sec.	
	C2- (S-Curve)	C2-01	S-Curve at Accelerating Start	0.2	0.0 ~ 4.0	0.1Sec.	
		C2-02	S-Curve at Accelerating End	0.2	0.0 ~ 4.0	0.1Sec.	
		C2-03	S-Curve at Decelerating Start	0.2	0.0 ~ 4.0	0.1Sec.	
		C2-04	S-Curve at Decelerating End	0.2	0.0 ~ 4.0	0.1Sec.	
	C3- (Motor Slip Comp.)	C3-01	Motor Rated Slip Compensation @ V/F CTL	0.0	0.0 ~ 200.0	0.1%	
		C3-02	Slip Compensation Delay Time @ V/F CTL	0.10	0.05 ~ 10.00	0.01Sec.	
	C4- (Torque Comp.)	C4-01	Torque Compensation @ V/F CTL	10.0	0.0 ~ 30.0	0.1%	
	C6- (Carrier Frequency)	C6-01	Carrier Frequency Set	5	1 ~ 15	1kHz	
		C6-06	Carrier Frequency Selection	1	0 ~ 2	
	D (Reference)	D1-(Preset References:)	D1-09	JOG Frequency Reference	2.00	0.00 ~ 650.00	0.01Hz
D1-10			JOG Acceleration Time	0.5	0.1 ~ 25.5	0.1Sec.	
D1-11			JOG Deceleration Time	0.5	0.1 ~ 25.5	0.1Sec.	
D1-12			Multi-step Speed ACC/DEC Time Selection	0	0 ~ 1	
D1-13			MOPs Speed/ Preset Speed 0	5.00	0.00 ~ 650.00	0.01Hz	
D1-14			Multi-Step Preset Speed 1	5.00	0.00 ~ 650.00	0.01Hz	
D1-15			Multi-Step Preset Speed 2	10.00	0.00 ~ 650.00	0.01Hz	
D1-16			Multi-Step Preset Speed 3	15.00	0.00 ~ 650.00	0.01Hz	
D1-17			Multi-Step Preset Speed 4	20.00	0.00 ~ 650.00	0.01Hz	
D1-18			Multi-Step Preset Speed 5	25.00	0.00 ~ 650.00	0.01Hz	
D1-19			Multi-Step Preset Speed 6	30.00	0.00 ~ 650.00	0.01Hz	
D1-20			Multi-Step Preset Speed 7	35.00	0.00 ~ 650.00	0.01Hz	
D1-21			Multi-Step Preset Speed 8	40.00	0.00 ~ 650.00	0.01Hz	
D1-22			Multi-Step Preset Speed 9	45.00	0.00 ~ 650.00	0.01Hz	
D1-23	Multi-Step Preset Speed 10	50.00	0.00 ~ 650.00	0.01Hz			

Function	Parameter No.	Name & (Digital Operator Displayed)	Default	Setting Range	Minimum Unit	User Setting		
D (Reference)	D1-(Preset References:)	D1-24	Multi-Step Preset Speed 11	0.00	0.00 ~ 650.00	0.01Hz		
		D1-25	Multi-Step Preset Speed 12	0.00	0.00 ~ 650.00	0.01Hz		
		D1-26	Multi-Step Preset Speed 13	0.00	0.00 ~ 650.00	0.01Hz		
		D1-27	Multi-Step Preset Speed 14	0.00	0.00 ~ 650.00	0.01Hz		
		D1-28	Multi-Step Preset Speed 15	0.00	0.00 ~ 650.00	0.01Hz		
		D1-29	ACC Time of REF Source/ Preset 0	10.0	0.1 ~ 3600.0	0.1Sec.		
		D1-30	DEC Time of REF Source/ Preset 0	10.0	0.1 ~ 3600.0	0.1Sec.		
		D1-31	ACC Time of Preset Speed 1	10.0	0.1 ~ 3600.0	0.1Sec.		
		D1-32	DEC Time of Preset Speed 1	10.0	0.1 ~ 3600.0	0.1Sec.		
		D1-33	ACC Time of Preset Speed 2	10.0	0.1 ~ 3600.0	0.1Sec.		
		D1-34	DEC Time of Preset Speed 2	10.0	0.1 ~ 3600.0	0.1Sec.		
		D1-35	ACC Time of Preset Speed 3	10.0	0.1 ~ 3600.0	0.1Sec.		
		D1-36	DEC Time of Preset Speed 3	10.0	0.1 ~ 3600.0	0.1Sec.		
		D1-37	ACC Time of Preset Speed 4	10.0	0.1 ~ 3600.0	0.1Sec.		
		D1-38	DEC Time of Preset Speed 4	10.0	0.1 ~ 3600.0	0.1Sec.		
		D1-39	ACC Time of Preset Speed 5	10.0	0.1 ~ 3600.0	0.1Sec.		
		D1-40	DEC Time of Preset Speed 5	10.0	0.1 ~ 3600.0	0.1Sec.		
		D1-41	ACC Time of Preset Speed 6	10.0	0.1 ~ 3600.0	0.1Sec.		
		D1-42	DEC Time of Preset Speed 6	10.0	0.1 ~ 3600.0	0.1Sec.		
		D1-43	ACC Time of Preset Speed 7	10.0	0.1 ~ 3600.0	0.1Sec.		
		D1-44	DEC Time of Preset Speed 7	10.0	0.1 ~ 3600.0	0.1Sec.		
		D1-45	ACC Time of Preset Speed 8	10.0	0.1 ~ 3600.0	0.1Sec.		
		D1-46	DEC Time of Preset Speed 8	10.0	0.1 ~ 3600.0	0.1Sec.		
		D1-47	ACC Time of Preset Speed 9	10.0	0.1 ~ 3600.0	0.1Sec.		
		D1-48	DEC Time of Preset Speed 9	10.0	0.1 ~ 3600.0	0.1Sec.		
		D1-49	ACC Time of Preset Speed 10	10.0	0.1 ~ 3600.0	0.1Sec.		
		D1-50	DEC Time of Preset Speed 10	10.0	0.1 ~ 3600.0	0.1Sec.		
		D1-51	ACC Time of Preset Speed 11	10.0	0.1 ~ 3600.0	0.1Sec.		
		D1-52	DEC Time of Preset Speed 11	10.0	0.1 ~ 3600.0	0.1Sec.		
		D1-53	ACC Time of Preset Speed 12	10.0	0.1 ~ 3600.0	0.1Sec.		
	D1-54	DEC Time of Preset Speed 12	10.0	0.1 ~ 3600.0	0.1Sec.			
	D1-55	ACC Time of Preset Speed 13	10.0	0.1 ~ 3600.0	0.1Sec.			
	D1-56	DEC Time of Preset Speed 13	10.0	0.1 ~ 3600.0	0.1Sec.			
	D1-57	ACC Time of Preset Speed 14	10.0	0.1 ~ 3600.0	0.1Sec.			
	D1-58	DEC Time of Preset Speed 14	10.0	0.1 ~ 3600.0	0.1Sec.			
	D1-59	ACC Time of Preset Speed 15	10.0	0.1 ~ 3600.0	0.1Sec.			
	D1-60	DEC Time of Preset Speed 15	10.0	0.1 ~ 3600.0	0.1Sec.			
		D2-(References Limits)	D2-01	Frequency Upper Limit	50.00	0.01 ~ 650.00	0.01Hz	
			D2-02	Frequency Lower Limit	0.00	0.00 ~ 649.99	0.01Hz	
		D3-(Jump Frequencies)	D3-01	Jump Frequency Reference 1	0.00	0.00 ~ 650.00	0.01Hz	
			D3-02	Jump Frequency Reference 2	0.00	0.00 ~ 650.00	0.01Hz	
			D3-03	Jump Frequency Reference 3	0.00	0.00 ~ 650.00	0.01Hz	
			D3-04	Jump Frequency Bandwidth	0.00	0.00 ~ 30.00	0.01Hz	

Function	Parameter No.	Name & (Digital Operator Displayed)	Default	Setting Range	Minimum Unit	User Setting	
E (V/F Pattern & Motor)	E1-(V/F Pattern for V/F CTL)	E1-01	Input Mains Voltage	220.0	170.0 ~ 528.0	0.1V	
		E1-03	V/F Pattern Selection	F	0 ~ F	
		E1-04	Maximum Output Frequency	50.00	40.00 ~ 650.00	0.01Hz	
		E1-05	Maximum Output Voltage	200.0	0.0 ~ 255.0*	0.1V	
		E1-06	Base Frequency	50.00	0.10 ~ 650.00	0.01Hz	
		E1-07	Middle Output Frequency A	2.50	0.10 ~ 650.00	0.01Hz	
		E1-08	Middle Output Voltage A	15.0	0.0 ~ 255.0*	0.1V	
		E1-09	Minimum Output Frequency	1.30	0.10 ~ 650.00	0.01Hz	
		E1-10	Minimum Output Voltage	9.0	0.0 ~ 255.0*	0.1V	
		E1-11	Middle Output Frequency B	0.00	0.00 ~ 650.00	0.01Hz	
		E1-12	Middle Output Voltage B	0.0	0.0 ~ 255.0*	0.1V	
		E1-13	Base Voltage	200.0	0.0 ~ 255.0*	0.1V	
		E1-14	V/F Start Frequency	0.00	0.00 ~ 10.00	0.01Hz	
		E2-(Motor Set-up for V/F CTL)	E2-01	Motor Rated Current	0.1A
E2-03	Motor No-Load Current		0.1A		
E2-04	Number of Motor Poles		4	2 ~ 48	2Poles		
E6-(Motor Direction)	E6-01	Motor Direction Selection	0	0 ~ 1		
H (Terminal)	H1-(Digital Inputs)	H1-01	Terminal D1 Selection	80	3 ~ 89	
		H1-02	Terminal D2 Selection	81	3 ~ 89	
		H1-03	Terminal D3 Selection	3	3 ~ 89	
		H1-04	Terminal D4 Selection	4	3 ~ 89	
		H1-05	Terminal D5 Selection	5	3 ~ 89	
		H1-06	Terminal D6 Selection	30	3 ~ 89	
		H1-11	D1~ D5 Input Signal Selection	00000	00000 ~ 11111	
		H1-12	D6 Input Signal Selection	00000	00000 ~ 00001	
		H1-13	MOP CTL Bandwidth	0.00	0.00 ~ 5.00	0.01Hz	
		H1-14	MOP Hold Reference Selection	0	0 ~ 2	
		H1-15	Pulse Input Signal Selection	0	0 ~ 1	
		H1-16	Pulse Input Filter Coefficient	1	1 ~ 100	1	
		H1-17	Pulse Input Gain	1.00	0.01 ~ 9.99	0.01	
		H1-18	Pulse Reference Filter for LCP	20	1 ~ 200	1	
	H1-19	Counter Target Value	0	0 ~ 9999	1		
	H1-20	Preset Counter Value	0	0 ~ 9999	1		
	H1-21	Counter Input Scan Time	1	1 ~ 10	1 (x2mS)		
	H2-(Digital Outputs)	H2-01	Relay 1 (RY1) Function Selection	E	0 ~ 48	
		H2-02	Relay 2 (RY2) Function Selection	0	0 ~ 48	
		H2-03	PHC Function Selection	2	0 ~ 48	
		H2-06	Digital Output Signal Selection	00000	00000 ~ 00111	
H3-(Analog Inputs)	H3-02	Terminal AVI Reference % Gain	100	0 ~ 1000	1%		
	H3-03	Terminal AVI Reference % Bias	0	0 ~ 100	1%		
	H3-09	Terminal ACI Function Selection	0	0 ~ 2		
	H3-10	Terminal ACI Reference % Gain	100	0 ~ 1000	1%		

Note: These Voltage Values are for the 200 V Class; Double the Values for 400 V Class VFDs.

Function	Parameter No.	Name & (Digital Operator Displayed)	Default	Setting Range	Minimum Unit	User Setting	
H (Terminal)	H3-(Analog Inputs)	H3-11	Terminal ACI Reference % Bias	0	0 ~ 100	1%	
		H3-12	Terminal AVI Scan Time	50	1 ~ 100	1 (x2mS)	
		H3-13	Terminal AVI/ACI Signal Selection	0	0 ~ 3	
		H3-14	Terminal AVI Bias +/- Selection	0	0 ~ 1	
		H3-15	AVI Normal/ Invert Selection	0	0 ~ 1	
		H3-16	Terminal ACI Scan Time	50	1 ~ 100	1 (x2mS)	
		H3-17	Terminal ACI Bias +/- Selection	0	0 ~ 1	
		H3-18	ACI Normal/ Invert Selection	0	0 ~ 1	
		H3-19	AI Reference Filter for LCP Display	30	1 ~ 100	1	
	H4-(Analog Outputs)	H4-01	Terminal AO Function Selection	2	1 ~ 7	
		H4-02	Terminal AO % Gain	100	0 ~ 1000	1%	
		H4-03	Terminal AO Reference % Bias	0	0 ~ 100	1	
		H4-09	Terminal AO Bias +/- Selection	0	0 ~ 1	
		H4-10	AO Normal/ Invert Selection	0	0 ~ 1	
	H5-(Modbus Communication Set-up)	H5-01	Modbus Station Address Selection	1	1 ~ 32	1	
		H5-02	Modbus Baud Rate Selection	3	0 ~ 4	
		H5-03	Modbus Parity Selection	0	0 ~ 2	
		H5-04	Stop Method if Modbus Error	0	0 ~ 3	
		H5-06	Modbus Response Delay Time	5	1 ~ 16	1 (x2mS)	
		H5-08	ASCII RTU Code Selection	0	0 ~ 1	
		H5-09	Modbus Stop Bit Selection	0	0 ~ 1	
H5-10		Modbus Data Format Selection	0	0 ~ 1		
H5-11		MODBUS Time Out Detection	0.0	0.0 ~ 25.5	0.1Sec.		
H5-12	Number of MODBUS Error	3	1 ~ 20	1			
L (Protection)	L1-(Motor Overload)	L1-06	Motor OL1 Selection	1	0 ~ 1	
		L1-07	Motor Cooling Type Selection	0	0 ~ 1	
		L1-08	Motor Overload Type Selection	0	0 ~ 1	
		L1-09	Stopping Method after OL1	0	0 ~ 1	
		L1-10	Motor Overload Protection Level	100	30 ~ 200	%	
		L1-11	Motor Overload Protection Time	20.0	0.1 ~ 100.0	0.1Sec.	
	L2-(Power Loss Ridethrough)	L2-01	Power Loss Selection	0	0 ~ 2	
		L2-02	Momentary Power Loss Time	0.5	0.0 ~ 2.0	0.1Sec.	
	L3-(Stall Prevention)	L3-01	Acceleration Stall Prevention	0	0 ~ 1	
		L3-02	ACC Stall Prevention Level	200	10 ~ 300	1%	
		L3-04	Deceleration Stall Prevention	0	0 ~ 2	
		L3-05	Running Stall Prevention	0	0 ~ 1	
		L3-06	Running Stall Prevention Level	200	10 ~ 300	1%	
		L3-07	DEC Stall Prevention Level	200	10 ~ 300	1%	
L3-08		Running Over Volt. Prevention	0	0 ~ 2		
L3-09		Running OV. Prevention Level	380.0	350.0 ~ 780.0	0.1v		
L3-10	Deceleration OV. Restraint Gain	10	0 ~ 20	1			

Function		Parameter No.	Name & (Digital Operator Displayed)	Default	Setting Range	Minimum Unit	User Setting
L (Protection)	L4- (Reference Detection)	L4-01	Frequency Agree Level	0.00	0.00 ~ 650.00	0.01Hz	
		L4-02	Frequency Agree Width	2.00	0.00 ~ 30.00	0.01Hz	
	L5- (Automatic Restart)	L5-01	Number of Automatic Restart	0	0 ~ 10	1	
		L5-03	Automatic Restart Method	0	0 ~ 1	
		L5-04	Automatic Restart Waiting Time	0.0	0.0 ~ 800.0	0.1Sec.	
		L5-05	Restart Mode Selection	0	0 ~ 1	
		L5-06	Direct Start after Power Up	0	0 ~ 1	
		L5-07	Direct Start Delay Time	2.0	2.0 ~ 300.0	0.1Sec.	
		L5-08	KEB Deceleration Time Setting	0.0	0.0 ~ 25.0	0.1Sec.	
		L5-09	DC Bus LV Detection Level	190.0	150.0 ~ 420.0	0.1V	
	L6-Over Current Detection	L6-01	Over Current Detection Selection	0	0 ~ 4	
		L6-02	Over Current Detection Level	150	10 ~ 200	1%	
		L6-03	Over Current Detection Delay Time	0.1	0.0 ~ 10.0	0.1Sec.	
	L8- (Hardware Protection)	L8-04	Built-in Cooling Fan Selection	1	0 ~ 3	
		L8-17	Carrier Frequency Auto Reduce Selection	0	0 ~ 1	
	O (Operator)	O1- (Monitor Selection)	O1-02	Monitoring after Power Up Selection	0	0 ~ 5
O1-06			RPM Scale for Monitoring	1800	0 ~ 65535	1 RPM	
O1-07			Scale for Monitoring Selection	0	0 ~ 4	
O2- (Key Selection)		O2-02	LCP Stop Key Selection	0	0 ~ 1	
		O2-04	Inverter Model	
		O2-05	LCP M.O.P. Mode Selection	0	0 ~ 1	
		O2-08	Accumulative Worked Time	0	0 ~ 1	
		O2-10	Allow Worked Days	0	0 ~ 65535	1Day	
O2-11	Parameter Lock by Password	0	0 ~ 1			
P (Process)	P1- (Auto Process Operation)	P1-00	Auto Process Mode Selection	0	0 ~ 6	
		P1-01	Master Frequency (Auto Process Speed 0)	0.00	0.00 ~ 650.00	0.01Hz	
		P1-02	Auto Process Speed 1	0.00	0.00 ~ 650.00	0.01Hz	
		P1-03	Auto Process Speed 2	0.00	0.00 ~ 650.00	0.01Hz	
		P1-04	Auto Process Speed 3	0.00	0.00 ~ 650.00	0.01Hz	
		P1-05	Auto Process Speed 4	0.00	0.00 ~ 650.00	0.01Hz	
		P1-06	Auto Process Speed 5	0.00	0.00 ~ 650.00	0.01Hz	
		P1-07	Auto Process Speed 6	0.00	0.00 ~ 650.00	0.01Hz	
		P1-08	Auto Process Speed 7	0.00	0.00 ~ 650.00	0.01Hz	
		P1-09	Auto Process Speed 8	0.00	0.00 ~ 650.00	0.01Hz	
		P1-10	Auto Process Speed 9	0.00	0.00 ~ 650.00	0.01Hz	
		P1-11	Auto Process Speed 10	0.00	0.00 ~ 650.00	0.01Hz	
		P1-12	Auto Process Speed 11	0.00	0.00 ~ 650.00	0.01Hz	
		P1-13	Auto Process Speed 12	0.00	0.00 ~ 650.00	0.01Hz	
		P1-14	Auto Process Speed 13	0.00	0.00 ~ 650.00	0.01Hz	
		P1-15	Auto Process Speed 14	0.00	0.00 ~ 650.00	0.01Hz	
P1-16	Auto Process Speed 15	0.00	0.00 ~ 650.00	0.01Hz			

Function	Parameter No.	Name & (Digital Operator Displayed)	Default	Setting Range	Minimum Unit	User Setting	
P (Process)	P1-(Auto Process Operation)	P1-17	Run Time 0 for Speed 0	0.0	0.0 ~ 3600.0	0.1Sec.	
		P1-18	Run Time 1 for Speed 1	0.0	0.0 ~ 3600.0	0.1Sec.	
		P1-19	Run Time 2 for Speed 2	0.0	0.0 ~ 3600.0	0.1Sec.	
		P1-20	Run Time 3 for Speed 3	0.0	0.0 ~ 3600.0	0.1Sec.	
		P1-21	Run Time 4 for Speed 4	0.0	0.0 ~ 3600.0	0.1Sec.	
		P1-22	Run Time 5 for Speed 5	0.0	0.0 ~ 3600.0	0.1Sec.	
		P1-23	Run Time 6 for Speed 6	0.0	0.0 ~ 3600.0	0.1Sec.	
		P1-24	Run Time 7 for Speed 7	0.0	0.0 ~ 3600.0	0.1Sec.	
		P1-25	Run Time 8 for Speed 8	0.0	0.0 ~ 3600.0	0.1Sec.	
		P1-26	Run Time 9 for Speed 9	0.0	0.0 ~ 3600.0	0.1Sec.	
		P1-27	Run Time 10 for Speed 10	0.0	0.0 ~ 3600.0	0.1Sec.	
		P1-28	Run Time 11 for Speed 11	0.0	0.0 ~ 3600.0	0.1Sec.	
		P1-29	Run Time 1 for Speed 12	0.0	0.0 ~ 3600.0	0.1Sec.	
		P1-30	Run Time 13 for Speed 13	0.0	0.0 ~ 3600.0	0.1Sec.	
		P1-31	Run Time 14 for Speed 14	0.0	0.0 ~ 3600.0	0.1Sec.	
		P1-32	Run Time 15 for Speed 15	0.0	0.0 ~ 3600.0	0.1Sec.	
		P1-33	Run Direction 0 for Speed 0	0	0 ~ 2	
		P1-34	Run Direction 1 for Speed 1	0	0 ~ 2	
		P1-35	Run Direction 2 for Speed 2	0	0 ~ 2	
		P1-36	Run Direction 3 for Speed 3	0	0 ~ 2	
		P1-37	Run Direction 4 for Speed 4	0	0 ~ 2	
		P1-38	Run Direction 5 for Speed 5	0	0 ~ 2	
		P1-39	Run Direction 6 for Speed 6	0	0 ~ 2	
		P1-40	Run Direction 7 for Speed 7	0	0 ~ 2	
		P1-41	Run Direction 8 for Speed 8	0	0 ~ 2	
		P1-42	Run Direction 9 for Speed 9	0	0 ~ 2	
		P1-43	Run Direction 10 for Speed 10	0	0 ~ 2	
		P1-44	Run Direction 11 for Speed 11	0	0 ~ 2	
		P1-45	Run Direction 1 for Speed 12	0	0 ~ 2	
		P1-46	Run Direction 13 for Speed 13	0	0 ~ 2	
		P1-47	Run Direction 14 for Speed 14	0	0 ~ 2	
		P1-48	Run Direction 15 for Speed 15	0	0 ~ 2	
T (VVT Adjusting)	T1- (Motor Nameplate Data)	T1-02	Motor Nameplate Power	0.1kW	
		T1-03	Motor Rated Voltage	0.1VAC	
		T1-04	Motor Rated Current	0.1A	
		T1-05	Motor Rated Frequency	0.01Hz	
		T1-07	Motor Rated Speed	1RPM	
	T2- (Motor Adjusting Constants)	T2-00	Torque Compensation Coefficient for VVT CTL	0 ~ 600	1	
		T2-01	Slip Compensation Coefficient for VVT CTL	0 ~ 600	1	
T2-05		Torque Compensation Gain @ Low Speed for VVT CTL	90	0 ~ 300	1%		

A.3 Abbreviation Index

In the Manual, there are Abbreviations with Uppercase Words because of limited space in some Tables, please refer the explanation below to know what the real meaning for the Word.

Alphabet	Abbreviation	Meaning
A	ACC	Acceleration/ Accerlative/ Accerlating
	AVR	Auto Voltage Regulation
B	BRK	Brake/ Braking
C	CMD	Command
	CPW	Constant Power (Area)
	CTL	Control/ Controlling
D	DEC	Deceleration/ Decelerative/ Decelerating
E	E.S.	Emergency Stop, Fast Stop
	ERR	Error
F	FBL	Feed Back Loss
	FRQ	Frequency
	FSD	Full Scale Deflection
	FUN	Function
	FWD	Forward
I	INT	Invert
	INV	Inverter
K	KPD	Keypad/ Operator/ Local Control Panel
L	LCP	Local Control Panel/ Keypad/ Operator
	LVL	Level
M	MOB	Modbus
	MOP(s)	Motor Operated Potentiometer
	MTR	Motor
N	N.C.	Normal Close
	N.O.	Normal Open
P	PHC	Photo-Coupler
	POT	Potentiometer of LCP
	PWR	Power
R	REF	Reference
	REV	Reverse
	RST	Reset/ Mains Terminal Label
	RY	Relay
S	SGN	Signal
	SPD	Speed
	STP	Stop
	SWF	Switching/ Carrier Frequency
T	TMN	Terminal(s)
V	VFD	Variable Frequency Drive
	VLT	Voltage
	VVT	Variable Vector Torque